

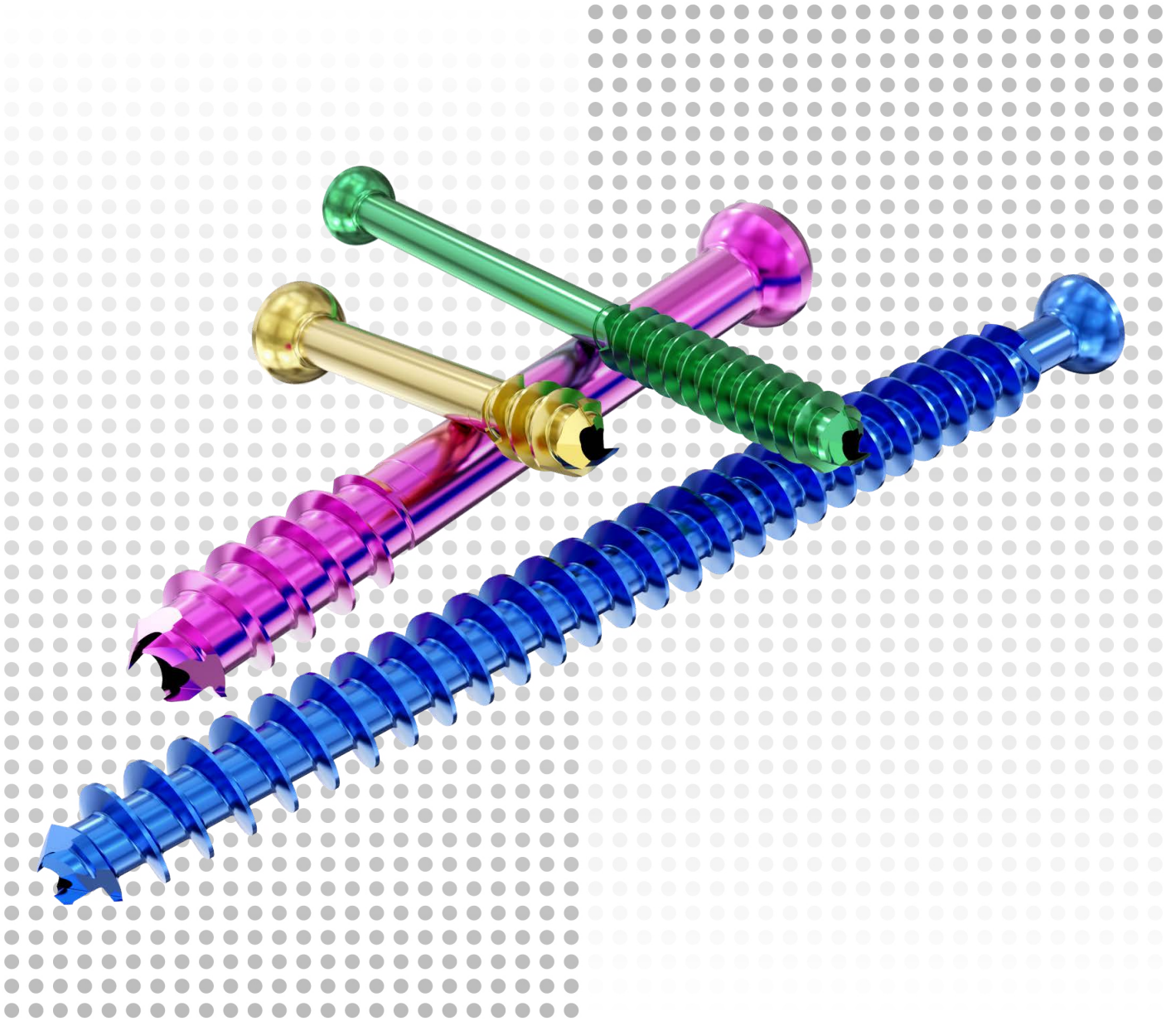

CANNULATED SCREW SYSTEM PLUS (CSS+)

2.0, 2.5, 3.0, 3.5, 4.0, 4.5, 5.5, 6.5, 7.5 mm
For Fixation of Various Bones and Bone Fragments

Surgical Technique



 Image intensifier control

This description alone does not provide sufficient background for direct use of DePuy Synthes products. Instruction by a surgeon experienced in handling these products is highly recommended.

Processing, Reprocessing, Care and Maintenance

For reprocessing guidelines for implants and instruments, please contact your local sales representative or refer to: [cssplus.info](https://www.cssplus.info)

Table of Contents

Introduction

Cannulated Screw System Plus (CSS+)	2
CSS+ Implant Size and Length Overview	3
Sterile Packaging	5
Sterilization	6
Indications and Contraindications	7
Warnings and Potential Risks	8
Precautions	9

Surgical Technique

Preparation and Insertion of Guide Wire	10
Screw Length Determination	11
Predrill and Tap (Optional)	12
Countersink (Optional)	14
Screw Insertion	15
Screw Removal	17
4.5/5.5/6.5/7.5 Instruments	19

Product Information

Implants	25
Instruments	34
Set Lists	46

MRI Information

47

- Notes
- ▲ Warnings

Cannulated Screw System Plus (CSS+)

System Overview

- Titanium alloy (Ti-6Al-4V ELI)
- Self-drilling/tapping cutting tip
- Comprehensive portfolio: Ø 2.0, 2.5, 3.0, 3.5, 4.0, 4.5, 5.5, 6.5, 7.5 mm
- Cannulated to allow for precise insertion over a guide wire
- Short, long, and full thread lengths for treating a wide range of anatomical regions
- Sterile and non-sterile packaging options
- Color-coded instrumentation
- Modular sets for flexibility
- Washers with countersunk feature for implant profile

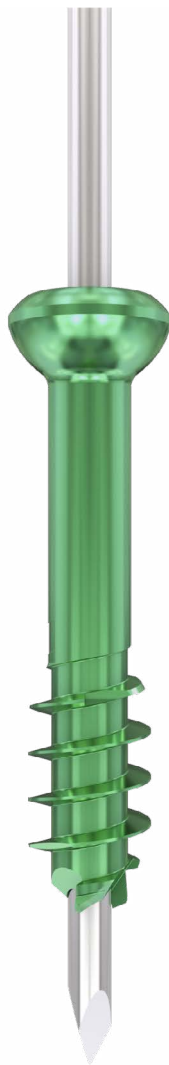

StarDrive Recess





















Reverse-cutting flutes
Facilitate screw removal



Self-drilling and self-tapping tip

CSS+ Implant Size and Length Overview

	2.0 	2.5 	3.0 	3.5 	4.0 	4.5 	5.5 	6.5 	7.5 
Guide Wire (Ø/L)	0.8/L 100 mm	1.1/L 150 mm		1.4/L 150 mm		1.6/L 220 mm		2.8/L 220, 300, 450 mm	
	trocár tip only	trocár or threaded tip						fluted or threaded tip	
Drill Bit Ø	1.6 mm	2.0 mm		2.7 mm		3.0 mm		5.0 mm	
Countersink	For 2.0 mm Headed Screws	For 2.5/3.0 mm Headed Screws		For 3.5/4.0 mm Headed Screws		For 4.5/5.5 mm Headed Screws		For 6.5/7.5 mm Headed Screws	
Drill Guide Ø	0.8/1.6 mm	1.1/2.0 mm		1.4/2.7 mm		1.6/3.0 mm		2.8/5.0 mm	
Direct Measuring Device	For 2.0 mm Screws	For 2.5/3.0/3.5/4.0 mm Screws				For 4.5/5.5/6.5/7.5 mm Screws			
						N/A		for 6.5/7.5 screws	
Screwdriver	T6 Cannulated	T8 Cannulated		T15 Cannulated				T30 Cannulated	
Handle	Small Handle with Jewelers Cap (Standard AO)			Large Ratcheting Handle (Standard AO)				Large Ratcheting Handle (Large QC)	
Drive Adapter	N/A							Large Quick Coupling (QC for Small Air Drill)	

Diameter	Color	Short Thread	Long Thread	Full Thread
2.0 mm		10-20 mm (1 mm increments) 22-30 mm (2 mm increments)	20-30 mm (2 mm increments)	N/A
		32-40 mm (2 mm increments, available sterile only)		
2.5 mm		10-20 mm (1 mm increments) 22-40 mm (2 mm increments)	20-40 mm (2 mm increments)	N/A
		45-55 mm (5 mm increments, available sterile only)		
3.0 mm		10-20 mm (1 mm increments) 22-40 mm (2 mm increments)	20-40 mm (2 mm increments)	N/A
		45-55 mm (5 mm increments, available sterile only)		
3.5 mm		10-60 mm (2 mm increments)	20-60 mm (2 mm increments)	10-60 mm (2 mm increments)
		65-75 mm (5 mm increments, available sterile only)		
4.0 mm		10-60 mm (2 mm increments)	20-60 mm (2 mm increments)	10-60 mm (2 mm increments)
		65-75 mm (5 mm increments, available sterile only)		
4.5 mm		20-50 mm (2 mm increments) 55-110 mm (5 mm increments)	30-50 mm (2 mm increments) 55-110 mm (5 mm increments)	20-50 mm (2 mm increments) 55-110 mm (5 mm increments)
		5.5 mm		20-50 mm (2 mm increments) 55-110 mm (5 mm increments)
6.5 mm		30-140 mm (5 mm increments)		45-140 mm (5 mm increments)
		145-180 mm (5 mm increments, available sterile only)		
7.5 mm		30-140 mm (5 mm increments)	45-140 mm (5 mm increments)	30-140 mm (5 mm increments)
		145-180 mm (5 mm increments, available sterile only)		

All implants are available sterile packed.

Sterile Packaging

The sterile packed Cannulated Screw System Plus is available in ready-to-use sterile tubes and double peel-pouch boxes. Availability of sterile packaging variant is dependent on the market.

For usage instructions on how to open the sterile tube packaging, refer to Sterile Tube Usage Guide.

Sterilization

All sterile products and sterile instruments are clearly marked “STERILE”. The sterile part is radiation sterilized. The package should be inspected prior to use to ensure the sterile barrier has not been compromised. Do not re-sterilize. Where specified, do not use the device after expiration date.

DePuy Synthes non-sterile instruments should be stored in the original packaging until cleaned and sterilized.

Consult the DePuy Synthes CSS+ system eIFU at cssplus.info for cleaning and sterilization instructions.

Indications and Contraindications

Indications

The DePuy Synthes Cannulated Screw System Plus Screws are indicated for use in bone reconstruction, osteotomy, arthrodesis, joint fusion, fracture repair, and fracture fixation of bones appropriate for the size of the device. Screws are intended for single use only.

Contraindications

The implant should not be used in a patient who has current, or who has a history of:

- Local or systemic acute or chronic inflammation;
- Active infection or inflammation;
- Suspected or documented metal allergy or intolerance

Consult the Cannulated Screw System Plus eIFU at cssplus.info for more information.

▲ Caution:

Federal Law (USA) restricts this device to sale by or on the order of a physician.

Warnings and Potential Risks

The CSS+ implants are designed for single patient use only and must never be reused. As with all other orthopedic implants, the components should never be re-implanted under any circumstances.

The CSS+ implants can become loose or break if subjected to increased loading. Factors such as the patient's weight, activity level, and adherence to weight-bearing or load-bearing instructions can affect the implant's longevity. Damage to the weight-bearing bone structures caused by infection can give rise to loosening of the components and/or fracture of the bone.

Serious postoperative complications may occur from the implant in a patient who: lacks good general physical conditions; has severe osteoporosis; demonstrates physiological or anatomical anomalies; has immunological responses, sensitization, or hypersensitivity to foreign materials; has systemic or metabolic disorders.

These warnings do not include all adverse effects which could occur with surgery but are important considerations specific to metallic devices. The risks associated with orthopedic surgery, general surgery, and the use of general anesthesia should be explained to the patient prior to surgery. See the **Precautions** section for additional warnings.

This device is not approved for screw attachment or fixation to the posterior elements (pedicles) of the cervical, thoracic or lumbar spine.

Precautions

Under no circumstances should damaged components or surgically excised components be used. Implants that have already been in contact with body fluids or body tissues must not be re-sterilized.

The CSS+ System should never be used with dissimilar materials. Preoperative assessment of the suitability of the patient's anatomy for accepting implants is made on the basis of X-rays, CT scans, and other radiological studies.

Only patients that meet the criteria described in the **Indications and Contraindications** section should be selected. Correct selection of the implant is extremely important. The morbidity as well as patient weight, height, occupation, and/or degree of physical activity should be considered.

Proper implant handling before and during the operation is crucial. Handle the implant components properly. Ensure packaging integrity. Do not allow the implants surfaces to be damaged.

Adequately instruct the patient. The physician should inform the patient about orthopedic implant advantages and disadvantages, postoperative limitations, weight/load bearing stresses which could affect bone healing, implant limitations, and the fact that premature physical activity and full weight/load-bearing stresses have been implicated in premature loosening, damage, and/or fracture of orthopedic prostheses.

▲ Important:

The guide wires included in the Cannulated Screw System Plus are not intended as implants. The guide wires are only intended for use as instruments to facilitate screw insertion.

The implantation of screws should be performed only by experienced surgeons with specific training in the use of this screw system because this is a technically demanding procedure presenting a risk of serious injury to the patient.

Preparation and Insertion of Guide Wire

Table 1 – Guide Wire, and Drill Guide Sizes

Screw Diameter	Guide Wires*	Drill Guides	
Ø 2.0 mm	03.333.000	0.8 mm Guide Wire/100 mm Length	
Ø 2.5 mm	03.333.001	1.1 mm Guide Wire/150 mm Length Trocar Tip	
Ø 3.0 mm	03.333.011	1.1 mm Threaded Guide Wire/150 mm Length	
Ø 3.5 mm	03.333.002	1.4 mm Guide Wire/150 mm Length Trocar Tip	
Ø 4.0 mm	03.333.012	1.4 mm Threaded Guide Wire/150 mm Length	
Ø 4.5 mm	03.333.003	1.6 mm Guide Wire/220 mm Length Trocar Tip	
Ø 5.5 mm	03.333.013	1.6 mm Threaded Guide Wire/220 mm Length	
Ø 6.5 mm Ø 7.5 mm	03.333.004	2.8 mm Guide Wire/220 mm Length Fluted Tip	
	03.333.014	2.8 mm Threaded Guide Wire/220 mm Length	
	03.333.005	2.8 mm Guide Wire/300 mm Length Fluted Tip	
	03.333.015	2.8 mm Threaded Guide Wire/300 mm Length	
	03.333.006S 03.333.016S	2.8 mm Guide Wire/450 mm Length Fluted tip, Sterile 2.8 mm Threaded Guide Wire/450 mm Length, Sterile	
		03.333.400	1.6 mm/0.8 mm Double Drill Guide
		03.333.401	2.0 mm/1.1 mm Double Drill Guide
		03.333.402	2.7 mm/1.4 mm Double Drill Guide
		03.333.403	3.0 mm/1.6 mm Double Drill Guide
		03.333.404	5.0 mm/ 2.8 mm Double Drill Guide
		03.333.702	11.0 mm/9.0 mm Tissue Protector
		03.333.706	11.0 mm/9.0 mm Tissue Protector Long

Select the correct guide wire and drill guide for the chosen screw diameter. (Table 1)

Make a stab incision and dissect a clean approach to the desired region of the bone where the cannulated screw will be inserted.

Reduce the bones intended to be repaired by the CSS+ screw.

Align the guide wire end of the drill guide in the direction of screw insertion. Place the guide wire through the drill guide and advance it into the bone to the desired depth and position. (Figure 1)

- Utilize image intensification to ensure correct guide wire position, alignment, and depth. Do not remove guide wire.

Notes:

- If using the Tissue Protector, the respective Guide Wire Sleeve should be inserted into the Tissue Protector. See the **4.5/5.5/6.5/7.5 Instruments Section** for further details.
- Cleaning the cannulation in each instrument is imperative for proper function. Instruments should be cleaned intraoperatively with a cleaning stylet to prevent accumulation of debris in the cannulation and potential binding of the instruments about the guide wire. Postoperatively, they should be cleaned with both a cleaning stylet and a cleaning brush.









*Instrument also available sterile packed. Add suffix "S" to Part Number.



Note: The drill guide drill end and guide wire end are distinguished by the diameter size callout, along with respective symbols.

Screw Length Determination

Table 2 – Guide Wire, and Direct Measuring Device (DMD) Sizes

Screw Diameter	Guide Wires*		Direct Measuring Devices (DMD)	
Ø 2.0 mm 	03.333.000	0.8 mm Guide Wire/100 mm Length	03.333.500	Direct Measuring Device for 100 mm wire
Ø 2.5 mm  Ø 3.0 mm 	03.333.001 03.333.011	1.1 mm Guide Wire/150 mm Length Trocar Tip 1.1 mm Threaded Guide Wire/150 mm Length	03.333.501	Direct Measuring Device for 150 mm wire
Ø 3.5 mm  Ø 4.0 mm 	03.333.002 03.333.012	1.4 mm Guide Wire/150 mm Length Trocar Tip 1.4 mm Threaded Guide Wire/150 mm Length		
Ø 4.5 mm  Ø 5.5 mm 	03.333.003 03.333.013	1.6 mm Guide Wire/220 mm Length Trocar Tip 1.6 mm Threaded Guide Wire/220 mm Length	03.333.502	Direct Measuring Device for 220 mm Wire
Ø 6.5 mm  Ø 7.5 mm 	03.333.004	2.8 mm Guide Wire/220 mm Length Fluted Tip	03.333.502	Direct Measuring Device for 220 mm Wire
	03.333.014	2.8 mm Threaded Guide Wire/220 mm Length		
	03.333.005	2.8 mm Guide Wire/300 mm Length Fluted Tip	03.333.503	Direct Measuring Device for 300 mm Wire
	03.333.015	2.8 mm Threaded Guide Wire/300 mm Length		
	03.333.006S 03.333.016S	2.8 mm Guide Wire/450 mm Length Fluted tip, Sterile 2.8 mm Threaded Guide Wire/450 mm Length, Sterile		

Select the correct direct measuring device (DMD) for the chosen screw diameter. (Table 2)

Slide the narrow end of the DMD over the guide wire and place it flush against the bone.

Record the measurement at the end of the guide wire to determine the depth of the guide wire in the bone. This depth should be used to determine the length of the corresponding screw (Figure 2). Subtract appropriately for any anticipated fracture reduction or interfragmentary compression resulting from screw insertion.

Notes:

- The observed reading on the direct measuring device reflects the depth of the guide wire in the bone. The screw length measurement includes the height of the head and is measured from the top of the head to the tip. As such, if not countersinking, selection of a slightly longer screw length than measured may be appropriate to compensate for the screw head height. Head heights per diameter/head + washer construct are listed in the **CSS+ implant specifications**.
- The DMD can be directly inserted through the Tissue Protector, without the Tissue Protector Guide Wire Sleeve, to measure the guide wire depth. See **4.5/5.5/6.5/7.5 Instruments Section** on pages 40-44 for additional instructions.

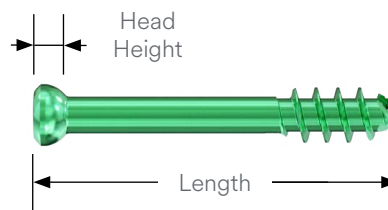
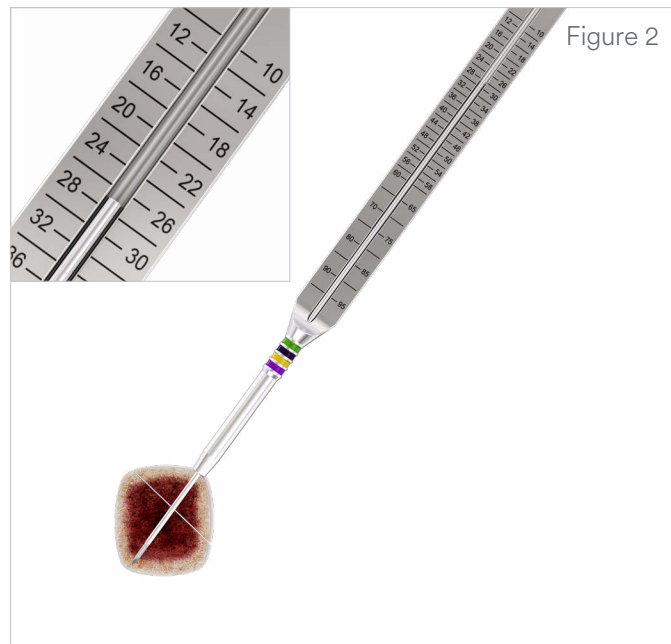

*Instrument also available sterile packed. Add suffix "S" to Part Number.

Predrill and Tap (Optional)

Table 3 – Guide Wire, Drill Bit, and Tap Sizes

Screw Diameter	Guide Wires*	Cannulated Drill Bits*	Taps*
Ø 2.0 mm	03.333.000 0.8 mm Guide Wire/100 mm Length	03.333.100 Cannulated Drill Bit Ø 1.6 mm, for Quick Coupling	N/A
Ø 2.5 mm Ø 3.0 mm	03.333.001 1.1 mm Guide Wire/150 mm Length Trocar Tip 03.333.011 1.1 mm Threaded Guide Wire/150 mm Length	03.333.101 Cannulated Drill Bit Ø 2.0 mm, for Quick Coupling	
Ø 3.5 mm Ø 4.0 mm	03.333.002 1.4 mm Guide Wire/150 mm Length Trocar Tip 03.333.012 1.4 mm Threaded Guide Wire/150 mm Length	03.333.102 Cannulated Drill Bit Ø 2.7 mm, for Quick Coupling	
Ø 4.5 mm Ø 5.5 mm	03.333.003 1.6 mm Guide Wire/220 mm Length Trocar Tip 03.333.013 1.6 mm Threaded Guide Wire/220 mm Length	03.333.103 Cannulated Drill Bit Ø 3.0 mm, for Quick Coupling	03.333.800 4.5 mm Cannulated Tap 03.333.801 5.5 mm Cannulated Tap
Ø 6.5 mm Ø 7.5 mm	03.333.004 2.8 mm Guide Wire/220 mm Length Fluted Tip 03.333.014 2.8 mm Threaded Guide Wire/ 220 mm Length 03.333.005 2.8 mm Guide Wire/300 mm Length Fluted Tip 03.333.015 2.8 mm Threaded Guide Wire/ 300 mm Length 03.333.006S 2.8 mm Guide Wire/450 mm Length Fluted tip, Sterile 03.333.016S 2.8 mm Threaded Guide Wire/ 450 mm Length, Sterile	03.333.104 Cannulated Drill Bit 5.0 mm, for Large Quick Coupling 03.333.112 Cannulated Drill Bit Ø 5.0 mm, for Large Quick Coupling/ Long 03.333.113S Cannulated Drill Bit Large QC/Long, Sterile	03.333.802 6.5 mm Cannulated Tap 03.333.803 7.5 mm Cannulated Tap

The cutting tip of the CSS+ screws make predrilling and tapping unnecessary in most cases; however, in very dense bone, it may be helpful to use the cannulated drill bit and tap. Select the correct drill size for the chosen screw diameter. (Table 3)

Align the drill guide over the guide wire. Place the drill through the drill guide and over the wire, and drill to the desired depth (Figure 3).

- Utilize image intensification to ensure correct drill alignment and depth. Back the drill out of the bone once the desired depth has been reached, without removing the guide wire.

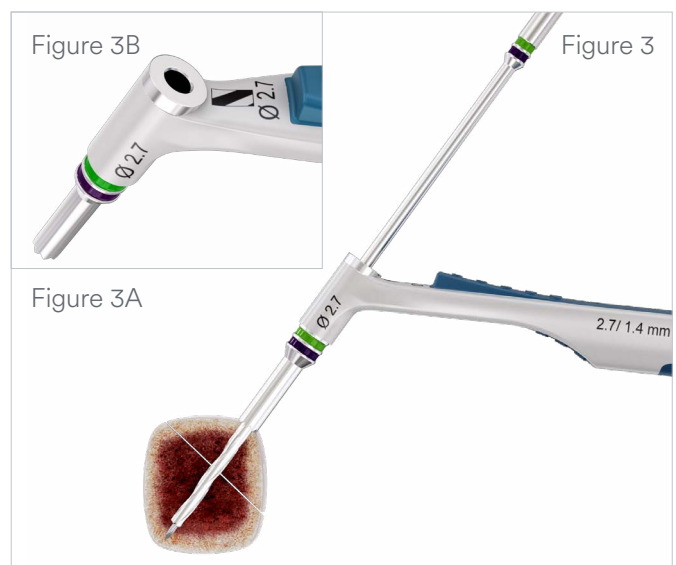

Note: The Double Drill Guide drill bit side (Figure 3B) is distinguished by the diameter size callout, along with respective symbols.

*Instrument also available sterile packed. Add suffix "S" to Part Number.

After drilling, select the correct size tap for the chosen screw diameter.

Align the tap over the guide wire. Place the tap through the tissue protector and over the wire, and tap to the desired depth.









- Utilize image intensification to ensure correct tap alignment and depth. Back the tap out of the bone once the desired depth has been reached, without removing the guide wire.

■ **Notes:**

- Drilling and tapping are optional due to the self-drilling, self-tapping features of the screws. For dense bone, predrilling may be required.
- Do not drill beyond the tip of the guide wire.
- Overdrill (03.333.113S) is available for 6.5/7.5 fully threaded screws if lag technique is desired. See Page 23 for additional details.
- When using a fully threaded screw, predrilling is recommended to reduce insertion torque.
- Not all screw diameters have corresponding taps.

Countersink (Optional)

Table 4 – Guide Wire, and Countersink Sizes

Screw Diameter	Guide Wires*	Countersinks*
Ø 2.0 mm 	03.333.000	0.8 mm Guide Wire/100 mm Length
Ø 2.5 mm  Ø 3.0 mm 	03.333.001 03.333.011	1.1 mm Guide Wire/150 mm Length Trocar Tip 1.1 mm Threaded Guide Wire/150 mm Length
Ø 3.5 mm  Ø 4.0 mm 	03.333.002 03.333.012	1.4 mm Guide Wire/150 mm Length Trocar Tip 1.4 mm Threaded Guide Wire/150 mm Length
Ø 4.5 mm  Ø 5.5 mm 	03.333.003 03.333.013	1.6 mm Guide Wire/220 mm Length Trocar Tip 1.6 mm Threaded Guide Wire/220 mm Length
Ø 6.5 mm  Ø 7.5 mm 	03.333.004 03.333.014 03.333.005 03.333.015 03.333.006S 03.333.016S	2.8 mm Guide Wire/220 mm Length Fluted Tip 2.8 mm Threaded Guide Wire/220 mm Length 2.8 mm Guide Wire/300 mm Length Fluted Tip 2.8 mm Threaded Guide Wire/300 mm Length 2.8 mm Guide Wire/450 mm Length Fluted tip, Sterile 2.8 mm Threaded Guide Wire/450 mm Length, Sterile
		03.333.210 03.333.211 03.333.212 03.333.213 03.333.214 03.333.215
		Countersink for Ø 2.0 mm Headed Screw, for Quick Coupling Countersink for Ø 2.5 mm and 3.0 mm Headed Screw, for Quick Coupling Countersink for Ø 3.5 mm and 4.0 mm Headed Screw, for Quick Coupling Countersink for Ø 4.5 mm and 5.5 mm Headed Screw, for Quick Coupling Countersink for 6.5 and 7.5 mm Headed Screw for Large Quick Coupling Long Countersink for Ø 6.5 mm and 7.5 mm Headed Screw for Large Quick Coupling

When a lower screw profile is desired, use the cannulated countersink to create a recess for the screw head.

Select the correct countersink for the chosen screw diameter. (Table 4)

Pass the countersink over the guide wire.

Advance the countersink tip into the bone by applying pressure and rotating the countersink clockwise to the desired depth.

The black line/laser etch (groove under fluoroscopy) on the head of the countersink represents the height of the screw head. (Figure 4)

■ Notes:

- When countersinking through the Tissue Protector, the laser marked band on the shaft corresponds to the depth of the head of the countersink. See **4.5/5.5/6.5/7.5 Instruments Section** for additional instructions.
- The headed CSS+ countersink has a black coat for quick differentiation against the headless CCHS countersink.









*Instrument also available sterile packed. Add suffix "S" to Part Number.

Figure 4



Screw Insertion

Table 5 – Guide Wire, Driver, Handle Sizes, and Washers

Screw Diameter	Guide Wires*		Cannulated Drivers		Handles	Washers		
Ø 2.0 mm 	03.333.000	0.8 mm Guide Wire/100 mm Length	03.333.300	T6 Screwdriver Shaft/ Self-Retain/ Cann	03.333.600	Small Screwdriver Handle/Cann/ Quick Coupling/with Jeweler Cap	04.353.900	Washer for 2.0 Cann Screw
Ø 2.5 mm  Ø 3.0 mm 	03.333.001	1.1 mm Guide Wire/150 mm Length Trocar Tip	03.333.302	T8 Screwdriver Shaft/ Self-Retain/ Cann			04.353.901	Washer for 2.5 Cann Screw
	03.333.011	1.1 mm Threaded Guide Wire/ 150 mm Length			04.353.902	Washer for 3.0 Cann Screw		
Ø 3.5 mm  Ø 4.0 mm 	03.333.002	1.4 mm Guide Wire/150 mm Length Trocar Tip	03.333.304	T15 Screwdriver Shaft/ Self-Retain/ Cann	03.333.601	Large Ratcheting Screwdriver Handle/Cann/ Quick Coupling	04.353.903	Washer for 3.5 Cann Screw
	03.333.012	1.4 mm Threaded Guide Wire/ 150 mm Length					04.353.904	Washer for 4.0 Cann Screw
Ø 4.5 mm  Ø 5.5 mm 	03.333.003	1.6 mm Guide Wire/220 mm Length Trocar Tip	03.333.304	T15 Screwdriver Shaft/ Self-Retain/ Cann	03.333.601	Large Ratcheting Screwdriver Handle/Cann/ Quick Coupling	04.353.905	Washer for 4.5 Cann Screw
	03.333.013	1.6 mm Threaded Guide Wire/ 220 mm Length					04.353.906	Washer for 5.5 Cann Screw
Ø 6.5 mm  Ø 7.5 mm 	03.333.004	2.8 mm Guide Wire/220 mm Length Fluted Tip	03.333.305	T30 Screwdriver Shaft/ Self-Retain/ Cann	03.333.602	Large Ratcheting Screwdriver Handle/ Cann/ Large Quick Coupling	04.353.907	Washer for 6.5 Cann Screw
	03.333.014	2.8 mm Threaded Guide Wire/ 220 mm Length						
	03.333.005	2.8 mm Guide Wire/300 mm Length Fluted Tip	03.333.311	T30 Screwdriver Shaft/ Self-Retain/ Cann Long	03.333.602	Large Ratcheting Screwdriver Handle/ Cann/ Large Quick Coupling	04.353.98	Washer for 7.5 Cann Screw
	03.333.015	2.8 mm Threaded Guide Wire/ 300 mm Length						
	03.333.006S	2.8 mm Guide Wire/450 mm Length Fluted tip, Sterile	03.333.311	T30 Screwdriver Shaft/ Self-Retain/ Cann Long	03.333.602	Large Ratcheting Screwdriver Handle/ Cann/ Large Quick Coupling	04.353.98	Washer for 7.5 Cann Screw
	03.333.016S	2.8 mm Threaded Guide Wire/ 450 mm Length, Sterile						

*Instrument also available sterile packed. Add suffix "S" to Part Number.

Select the correct cannulated driver and handle for the chosen screw diameter. (Table 5)

Pass the screw over the guide wire and advance the screw to the desired depth by rotating the driver clockwise. (Figures 5A and 5B)

- Utilize image intensification to ensure correct positioning of the screw.

Remove the guide wire.

Notes:

- If screw insertion is performed using power, it is recommended that final seating be completed by hand.
- In osteoporotic bone, a washer may be used to prevent the screw head from sinking into the bone.
- If using the overdrill (03.333.113S) for 6.5 or 7.5 screws, a washer is always recommended.
- The 4.5/5.5/6.5/7.5 Washers cannot be inserted through the corresponding tissue protector. If using a washer, screw insertion cannot be done through the tissue protector.

Figure 5A



Figure 5B

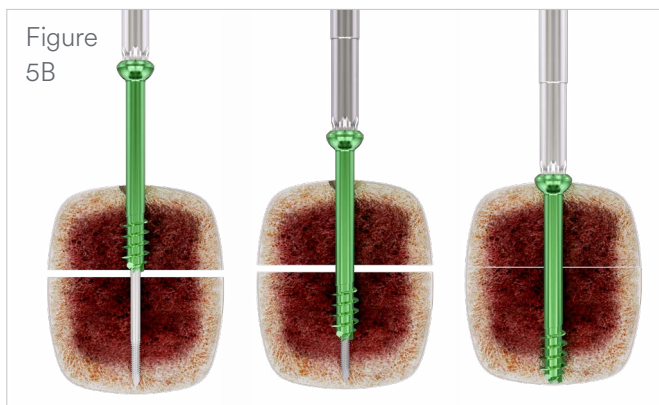

Screw Removal

Table 6 – Guide Wire, Driver, and Handle Sizes

Screw Diameter	Guide Wires	Screwdrivers	Handles			
Ø 2.0 mm 	03.333.000	0.8 mm Guide Wire/100 mm Length	03.333.600	Small Screwdriver Handle/Cann/Quick Coupling/with Jeweler Cap		
Ø 2.5 mm  Ø 3.0 mm 	03.333.001	1.1 mm Guide Wire/150 mm Length Trocar Tip	03.333.302	T8 Screwdriver Shaft/Self-Retain/Cann		
	03.333.011	1.1 mm Threaded Guide Wire/150 mm Length	03.333.303	T8 Screwdriver Shaft/Self-Retain/Solid		
Ø 3.5 mm  Ø 4.0 mm 	03.333.002	1.4 mm Guide Wire/150 mm Length Trocar Tip	03.333.304	T15 Screwdriver Shaft/Self-Retain/Cann		
	03.333.012	1.4 mm Threaded Guide Wire/150 mm Length				
Ø 4.5 mm  Ø 5.5 mm 	03.333.003	1.6 mm Guide Wire/220 mm Length Trocar Tip	03.333.306	T15 Screwdriver Shaft/Self-Retain/Solid		
	03.333.013	1.6 mm Threaded Guide Wire/220 mm Length				
Ø 6.5 mm  Ø 7.5 mm 	03.333.004	2.8 mm Guide Wire/220 mm Length Fluted Tip	03.333.305	T30 Screwdriver Shaft/Self-Retain/Cann		
	03.333.014	2.8 mm Threaded Guide Wire/220 mm Length				
	03.333.005	2.8 mm Guide Wire/300 mm Length Fluted Tip			03.333.310	T30 Screwdriver Shaft/Self-Retain/Solid
	03.333.015	2.8 mm Threaded Guide Wire/300 mm Length			03.333.311	T30 Screwdriver Shaft/Self-Retain/Cann/Long
	03.333.006S	2.8 mm Guide Wire/450 mm Length Fluted tip, Sterile			03.333.312	T30 Screwdriver Shaft/Self-Retain/Solid/Long
	03.333.016S	2.8 mm Threaded Guide Wire/450 mm Length, Sterile				

The screw may be removed by using the drivers indicated in Table 6.

Clear any tissue overgrowth from the screw head recess. Insert the driver and turn counterclockwise.

If alignment is difficult, a guide wire may be inserted through the screw cannula to facilitate driver alignment. In this case the cannulated driver must be used.

■ **Note:**

- **In case of difficult removal circumstances, a Screw Extraction Set (036.000.917) is available with corresponding instructions.**

4.5/5.5/6.5/7.5 Instruments

Large Quick Coupling

■ **Note:**

The Large Quick Coupling Male Coupling contains a feature compatible with a Jacob's Chuck. (Figure 6A)



Tissue Protectors

The 4.5/5.5/6.5/7.5 sets contain a tissue protector and corresponding guide wire sleeve. The guide wire sleeve fits inside the sleeve of the tissue protector (Figure 6B) and is self retaining. Once the guide wire is inserted through the guide wire sleeve, the sleeve should be removed from the tissue protector. (Figure 6C) To remove, pull the exposed end of the guide wire sleeve. All subsequent steps can be performed through the sleeve of the tissue protector (measuring guide wire length, drilling, countersinking, and screw insertion.)

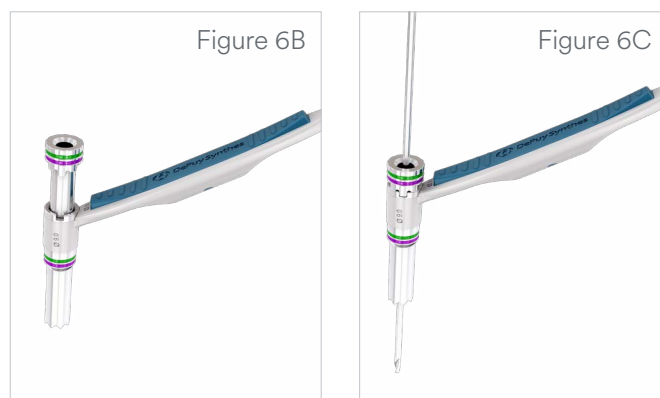

Tissue Protector – Long

The 6.5/7.5 Large Long Instrument set contains a tissue protector and corresponding guide wire sleeve. The guide wire sleeve fits inside the sleeve of the tissue protector (Figure 6B) and is self retaining. Once the guide wire is inserted through the guide wire sleeve, the sleeve should be removed from the tissue protector. (Figure 6C) To remove, squeeze and pull the exposed end of the guide wire sleeve. All subsequent steps can be performed through the sleeve of the tissue protector (measuring guide wire length, drilling, countersinking, and screw insertion.)



Drills through Tissue Protectors

■ Notes:

- Prior to drilling, leave the guide wire in place and remove the guide wire sleeve. (Figure 6D)
- For the 5.0 mm drill (03.333.104), to achieve a drill depth of 105 mm or longer, the Jacob's chuck must be utilized when drilling through the tissue protector.
- The 5.0 drill can drill up to 134 mm through the tissue protector.
- The 5.0 mm long drill (03.333.112) can drill up to 140 mm through the long tissue protector (03.333.706)

Figure 6F

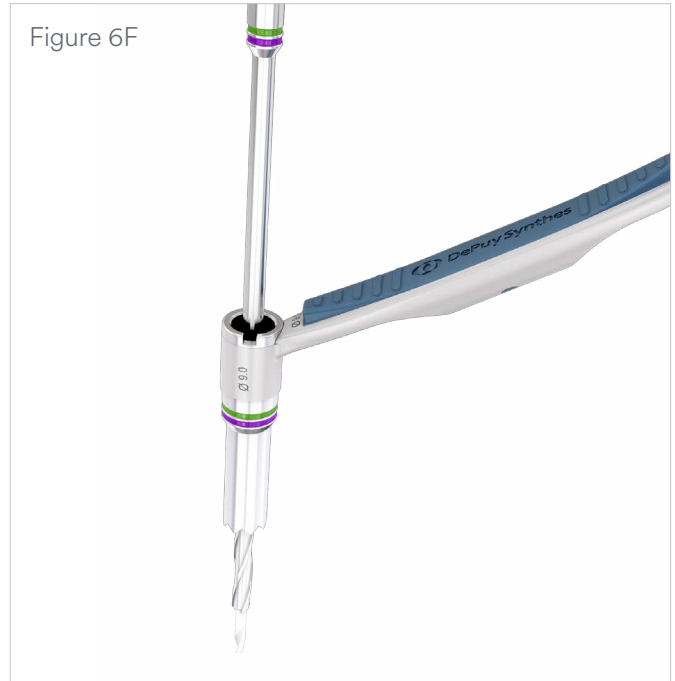

Countersinks

Note:

When countersinking through the tissue protector, the laser etch band in relationship with the top of the tissue protector indicates the height of the screw head. (Figure 7A)



Handles

Note:

The Large Quick Connect Handle has a laser mark for alignment to the groove flat on the instrument. (Figure 7B)

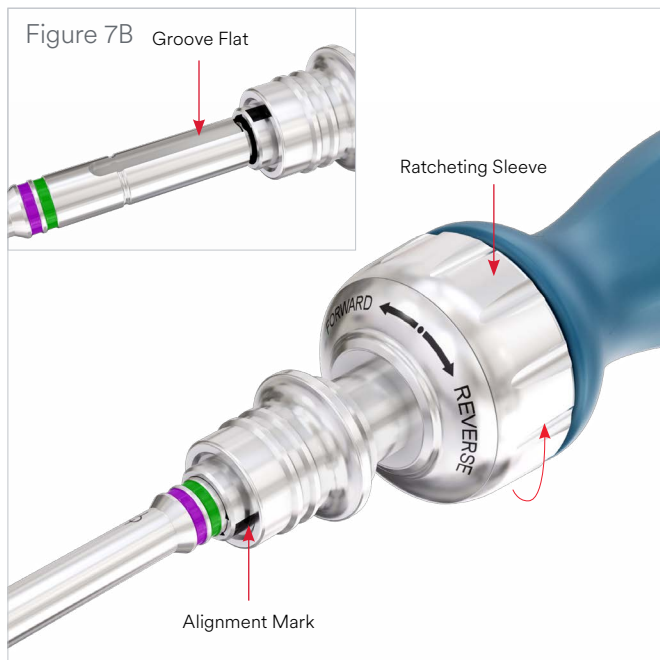

Adapter (338.49)/Quick Coupling for Small Air Drill (338.490)

■ **Note:**

The Large Quick Coupling is a solid instrument and only compatible for use with screws 70 mm in length or longer. (Figure 8)

Figure 8



Modular Instruments

The 6.5/7.5 Large long instrument set contains a non-ratcheting handle that is interchangeable between the wire guides and tissue protector.

■ **Note:**

The 6.5/7.5 Large Long Instrument Handle is a solid handle and is only compatible for use with the wire guides and tissue protector contained in the Large Long Instrument Set.



Adjustable Parallel Wire Guide

The adjustable parallel wire guide can be used to place parallel guide wires at various distances from the first wire.

To use:

Place the fixed sleeve over the previously inserted wire and adjust the movable sleeve to the desired position and distance. Tighten the nut on the adjustable sleeve to lock it in place. Insert additional guide wire. Loosen the nut and remove instrument from wires.



Multiple Wire Guide

To Use:

Insert the multiple wire guide and trocar through the incision and soft tissue to the bone. Remove the trocar. Select hole pattern and insert guide wires through the chosen holes. Once all wires are placed, remove instrument and use tissue protector for the remainder of the procedure.



■ Notes:

The placement of the holes in the multiple wire guide provide enough clearance for screws in adjacent holes. If clearance for washers is desired, only non-adjacent holes should be used to prevent overlap and interference.

- Pattern of holes on the parallel wire guide
- Washers may be used with the screws if the guide wires are inserted in non-adjacent holes of the wire guides
- Placing the guide wires through adjacent holes will allow clearance for screws but not for washers

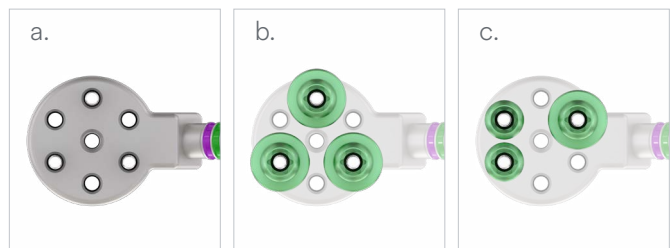

7.5 mm Cannulated Drill

The 7.5 mm Cannulated Drill is available sterile packed only and is intended to be used as an overdrill perform a lag screw technique when using either a Ø6.5 or Ø7.5 Fully Threaded Screw. This drill has a red epoxy band to distinguish it from other drills. Use of a washer is always recommended when using the 7.5 mm drill to create a gliding hole.



6.5/7.5 mm Large Instrument Sets

For the 6.5/7.5 mm CSS+, there are two separate sets available for use with different instrumentation.

6.5/7.5 Large Long Instrument Set

- This set has guide wires measured at 300 mm long (450 mm guide wire additionally available) with corresponding long instrumentation such as, but not limited to, drivers, tissue protectors, DMDs and countersinks.
- The set also includes additional instrumentation including the handle for guides, multiple wire guide, adjustable parallel guide, and 11.0 mm/9.0 mm long tissue protector.

6.5/7.5 Large Set

- This set has guide wires measured at 220 mm long with corresponding shorter instrumentation such as, but not limited to, drivers, tissue protectors, DMDs, double drill guides and countersinks.
- The handle for guides, multiple wire guide, adjustable parallel guides, and 11.0 mm/9.0 mm long tissue protector are not available.

Implants

CSS+ Ø 2.0 mm

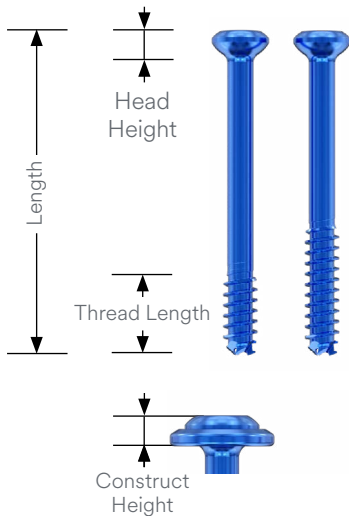

Head Height: 1.65 mm

Washer and Head Construct Height: 1.44 mm

Thread Length

Short Thread: approx. 25% Total Length or 4 mm

Long Thread: approx. 40% Total Length

Length (mm)	Short Thread Part Number	Thread Length (mm)	Long Thread Part Number	Thread Length (mm)
10	04.353.010	4	N/A	
11	04.353.011	4		
12	04.353.012	4		
13	04.353.013	4		
14	04.353.014	4		
15	04.353.015	4		
16	04.353.016	4		
17	04.353.017	4		
18	04.353.018	5		
19	04.353.019	5		
20	04.353.020	5	04.354.020	8
22	04.353.022	6	04.354.022	9
24	04.353.024	6	04.354.024	10
26	04.353.026	7	04.354.026	10
28	04.353.028	7	04.354.028	11
30	04.353.030	8	04.354.030	12
32	04.353.032TS	8	04.354.032TS	13
34	04.353.034TS	9	04.354.034TS	14
36	04.353.036TS	9	04.354.036TS	14
38	04.353.038TS	10	04.354.038TS	15
40	04.353.040TS	10	04.354.040TS	16

■ Sterile Packed Only

Washer – Ø 2.0 mm

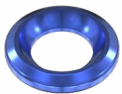

04.353.900.05	Washer For 2.0 Cann Screw + 5pk
04.353.900S	Washer For 2.0 Cann Screw + Sterile

All implants for this diameter are also available sterile packed. Sterile part availability might be different depending on the country or region.

CSS+ Ø 2.5 mm

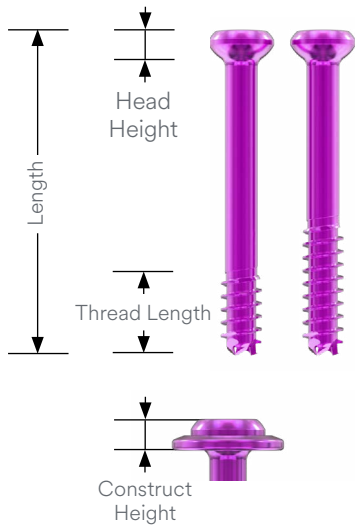

Head Height: 1.9 mm

Washer and Head Construct Height: 1.67 mm

Thread Length

Short Thread: approx. 25% Total Length or 4 mm

Long Thread: approx. 40% Total Length

Length (mm)	Short Thread Part Number	Thread Length (mm)	Long Thread Part Number	Thread Length (mm)
10	04.353.110	4	N/A	
11	04.353.111	4		
12	04.353.112	4		
13	04.353.113	4		
14	04.353.114	4		
15	04.353.115	4		
16	04.353.116	4		
17	04.353.117	4		
18	04.353.118	5		
19	04.353.119	5		
20	04.353.120	5	04.354.120	8
22	04.353.122	6	04.354.122	9
24	04.353.124	6	04.354.124	10
26	04.353.126	7	04.354.126	10
28	04.353.128	7	04.354.128	11
30	04.353.130	8	04.354.130	12
32	04.353.132	8	04.354.132	13
34	04.353.134	9	04.354.134	14
36	04.353.136	9	04.354.136	14
38	04.353.138	10	04.354.138	15
40	04.353.140	10	04.354.140	16
45	04.353.145TS	11	04.354.145TS	18
50	04.353.150TS	13	04.354.150TS	20
55	04.353.155TS	14	04.354.155TS	22

■ Sterile Packed Only

Washer – Ø 2.5 mm



04.353.901.05	Washer For 2.5 Cann Screw + 5pk
04.353.901S	Washer For 2.5 Cann Screw + Sterile

All implants for this diameter are also available sterile packed. Sterile part availability might be different depending on the country or region.

CSS+ Ø 3.0 mm

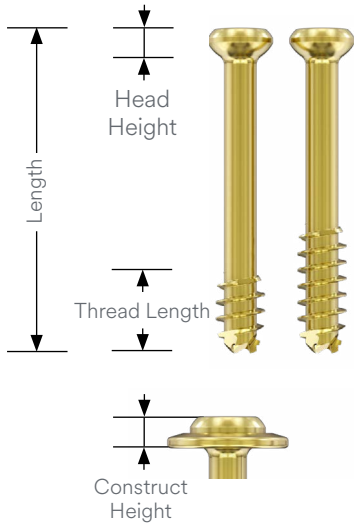

Head Height: 1.9 mm

Washer and Head Construct Height: 1.67 mm

Thread Length

Short Thread = approx. 25% Total Length or 4 mm

Long Thread = approx. 40% Total Length

Length (mm)	Short Thread Part Number	Thread Length (mm)	Long Thread Part Number	Thread Length (mm)
10	04.353.210	4	N/A	
11	04.353.211	4		
12	04.353.212	4		
13	04.353.213	4		
14	04.353.214	4		
15	04.353.215	4		
16	04.353.216	4		
17	04.353.217	4		
18	04.353.218	5		
19	04.353.219	5		
20	04.353.220	5	04.354.220	8
22	04.353.222	6	04.354.222	9
24	04.353.224	6	04.354.224	10
26	04.353.226	7	04.354.226	10
28	04.353.228	7	04.354.228	11
30	04.353.230	8	04.354.230	12
32	04.353.232	8	04.354.232	13
34	04.353.234	9	04.354.234	14
36	04.353.236	9	04.354.236	14
38	04.353.238	10	04.354.238	15
40	04.353.240	10	04.354.240	16
45	04.353.245TS	11	04.354.245TS	18
50	04.353.250TS	13	04.354.250TS	20
55	04.353.255TS	14	04.354.255TS	22

■ Sterile Packed Only

Washer – Ø 3.0 mm



04.353.902.05	Washer For 3.0 Cann Screw + 5pk
04.353.902S	Washer For 3.0 Cann Screw + Sterile

All implants for this diameter are also available sterile packed. Sterile part availability might be different depending on the country or region.

CSS+ Ø 3.5 mm

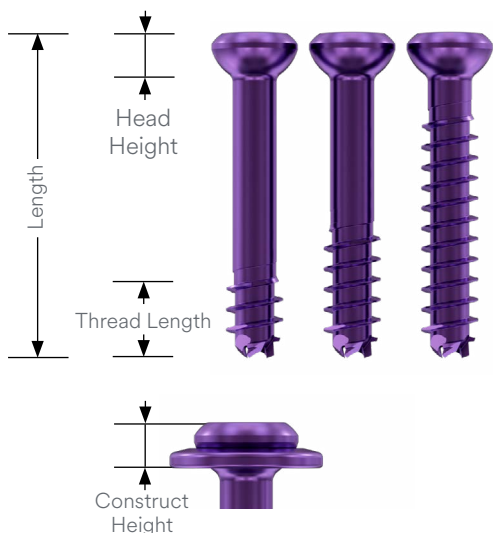

Head Height: 2.7 mm

Washer and Head Construct Height: 2.29 mm

Thread Length

Short Thread = approx. 25% Total Length or 4 mm

Long Thread = approx. 40% Total Length

Full Thread = Total Length minus 5 mm

Length (mm)	Short Thread Part Number	Thread Length (mm)	Long Thread Part Number	Thread Length (mm)	Full Thread Part Number	Thread Length (mm)
10	04.353.310	4	N/A		04.355.310	5
12	04.353.312	4			04.355.312	7
14	04.353.314	4			04.355.314	9
16	04.353.316	4			04.355.316	11
18	04.353.318	5			04.355.318	13
20	04.353.320	5	04.354.320	8	04.355.320	15
22	04.353.322	6	04.354.322	9	04.355.322	17
24	04.353.324	6	04.354.324	10	04.355.324	19
26	04.353.326	7	04.354.326	10	04.355.326	21
28	04.353.328	7	04.354.328	11	04.355.328	23
30	04.353.330	8	04.354.330	12	04.355.330	25
32	04.353.332	8	04.354.332	13	04.355.332	27
34	04.353.334	9	04.354.334	14	04.355.334	29
36	04.353.336	9	04.354.336	14	04.355.336	31
38	04.353.338	10	04.354.338	15	04.355.338	33
40	04.353.340	10	04.354.340	16	04.355.340	35
42	04.353.342	11	04.354.342	17	04.355.342	37
44	04.353.344	11	04.354.344	18	04.355.344	39
46	04.353.346	12	04.354.346	18	04.355.346	41
48	04.353.348	12	04.354.348	19	04.355.348	43
50	04.353.350	13	04.354.350	20	04.355.350	45
52	04.353.352	13	04.354.352	21	04.355.352	47
54	04.353.354	14	04.354.354	22	04.355.354	49
56	04.353.356	14	04.354.356	22	04.355.356	51
58	04.353.358	15	04.354.358	23	04.355.358	53
60	04.353.360	15	04.354.360	24	04.355.360	55
65	04.353.365S	16	04.354.365S	26	04.355.365S	60
70	04.353.370S	18	04.354.370S	28	04.355.370S	65
75	04.353.375S	19	04.354.375S	30	04.355.375S	70

■ Sterile Packed Only

Washer – Ø 3.5 mm



04.353.903.05	Washer For 3.5 Cann Screw + 5pk
04.353.903S	Washer For 3.5 Cann Screw + Sterile

All implants for this diameter are also available sterile packed. Sterile part availability might be different depending on the country or region.

CSS+ Ø 4.0 mm

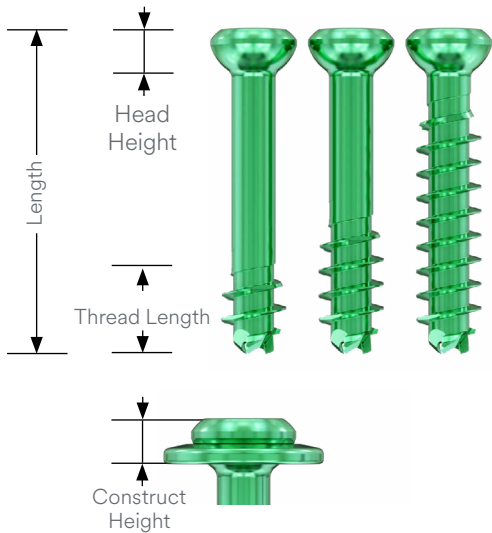

Head Height: 2.7 mm

Washer and Head Construct Height: 2.29 mm

Thread Length

Short Thread = approx. 25% Total Length or 5 mm

Long Thread = approx. 40% Total Length

Full Thread = Total Length minus 5 mm

Length (mm)	Short Thread Part Number	Thread Length (mm)	Long Thread Part Number	Thread Length (mm)	Full Thread Part Number	Thread Length (mm)
10	04.353.410	5	N/A		04.355.410	5
12	04.353.412	5			04.355.412	7
14	04.353.414	5			04.355.414	9
16	04.353.416	5			04.355.416	11
18	04.353.418	5			04.355.418	13
20	04.353.420	5	04.354.420	8	04.355.420	15
22	04.353.422	6	04.354.422	9	04.355.422	17
24	04.353.424	6	04.354.424	10	04.355.424	19
26	04.353.426	7	04.354.426	10	04.355.426	21
28	04.353.428	7	04.354.428	11	04.355.428	23
30	04.353.430	8	04.354.430	12	04.355.430	25
32	04.353.432	8	04.354.432	13	04.355.432	27
34	04.353.434	9	04.354.434	14	04.355.434	29
36	04.353.436	9	04.354.436	14	04.355.436	31
38	04.353.438	10	04.354.438	15	04.355.438	33
40	04.353.440	10	04.354.440	16	04.355.440	35
42	04.353.442	11	04.354.442	17	04.355.442	37
44	04.353.444	11	04.354.444	18	04.355.444	39
46	04.353.446	12	04.354.446	18	04.355.446	41
48	04.353.448	12	04.354.448	19	04.355.448	43
50	04.353.450	13	04.354.450	20	04.355.450	45
52	04.353.452	13	04.354.452	21	04.355.452	47
54	04.353.454	14	04.354.454	22	04.355.454	49
56	04.353.456	14	04.354.456	22	04.355.456	51
58	04.353.458	15	04.354.458	23	04.355.458	53
60	04.353.460	15	04.354.460	24	04.355.460	55
65	04.353.465S	16	04.354.465S	26	04.355.465S	60
70	04.353.470S	18	04.354.470S	28	04.355.470S	65
75	04.353.475S	19	04.354.475S	30	04.355.475S	70

■ Sterile Packed Only

Washer – Ø 4.0 mm

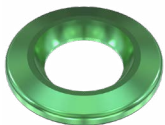

04.353.904.05	Washer For 4.0 Cann Screw + 5pk
04.353.904S	Washer For 4.0 Cann Screw + Sterile

All implants for this diameter are also available sterile packed. Sterile part availability might be different depending on the country or region.

CSS+ Ø 4.5 mm

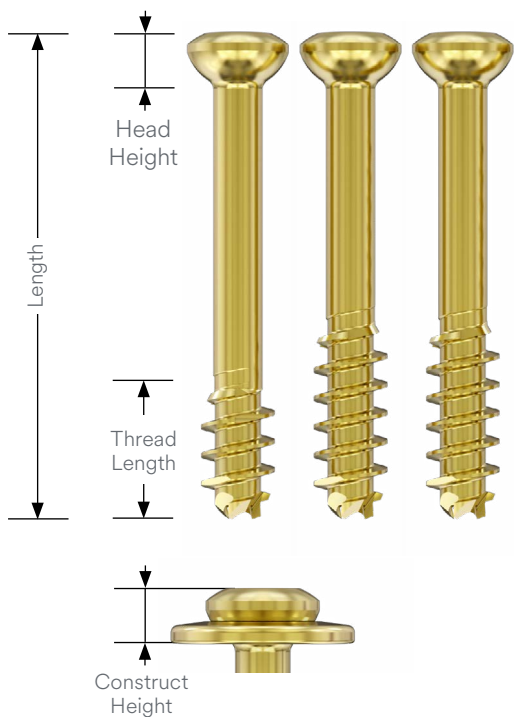

Head Height: 3.15 mm

Washer and Head Construct Height: 3.01 mm

Thread Length

Short Thread = approx. 25% Total Length or 8 mm

Long Thread = approx. 40% Total Length

Full Thread = Total Length minus 5.5 mm

Length (mm)	Short Thread Part Number	Thread Length (mm)	Long Thread Part Number	Thread Length (mm)	Full Thread Part Number	Thread Length (mm)
20	04.353.520	8	N/A		04.355.520	14.5
22	04.353.522	8			04.355.522	16.5
24	04.353.524	8			04.355.524	18.5
26	04.353.526	8			04.355.526	20.5
28	04.353.528	8			04.355.528	22.5
30	04.353.530	8	04.354.530	12	04.355.530	24.5
32	04.353.532	8	04.354.532	13	04.355.532	26.5
34	04.353.534	9	04.354.534	14	04.355.534	28.5
36	04.353.536	9	04.354.536	14	04.355.536	30.5
38	04.353.538	10	04.354.538	15	04.355.538	32.5
40	04.353.540	10	04.354.540	16	04.355.540	34.5
42	04.353.542	11	04.354.542	17	04.355.542	36.5
44	04.353.544	11	04.354.544	18	04.355.544	38.5
46	04.353.546	12	04.354.546	18	04.355.546	40.5
48	04.353.548	12	04.354.548	19	04.355.548	42.5
50	04.353.550	13	04.354.550	20	04.355.550	44.5
55	04.353.555	14	04.354.555	22	04.355.555	49.5
60	04.353.560	15	04.354.560	24	04.355.560	54.5
65	04.353.565	16	04.354.565	26	04.355.565	59.5
70	04.353.570	18	04.354.570	28	04.355.570	64.5
75	04.353.575	19	04.354.575	30	04.355.575	69.5
80	04.353.580	20	04.354.580	32	04.355.580	74.5
85	04.353.585	21	04.354.585	34	04.355.585	79.5
90	04.353.590	23	04.354.590	36	04.355.590	84.5
95	04.353.595	24	04.354.595	38	04.355.595	89.5
100	04.353.500	25	04.354.500	40	04.355.500	94.5
105	04.353.501	26	04.354.501	42	04.355.501	99.5
110	04.353.502	28	04.354.502	44	04.355.502	104.5

Washer – Ø 4.5 mm

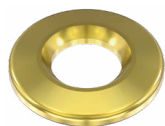

04.353.905.05	Washer For 4.5 Cann Screw + 5pk
04.353.905S	Washer For 4.5 Cann Screw + Sterile

All implants for this diameter are also available sterile packed. Sterile part availability might be different depending on the country or region.

CSS+ Ø 5.5 mm

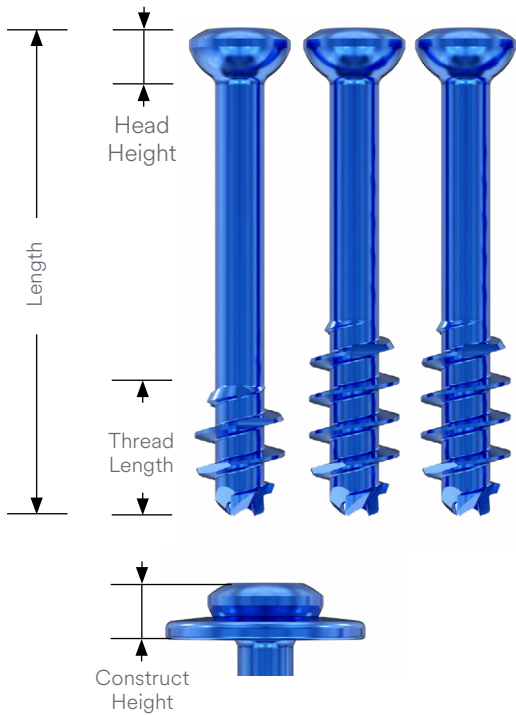

Head Height: 3.15 mm

Washer and Head Construct Height: 3.01 mm

Thread Length

Short Thread = approx. 25% Total Length or 8 mm

Long Thread = approx. 40% Total Length

Full Thread = Total Length minus 6 mm

Length (mm)	Short Thread Part Number	Thread Length (mm)	Long Thread Part Number	Thread Length (mm)	Full Thread Part Number	Thread Length (mm)
20	04.353.620	8	N/A		04.355.620	14
22	04.353.622	8			04.355.622	16
24	04.353.624	8			04.355.624	18
26	04.353.626	8			04.355.626	20
28	04.353.628	8			04.355.628	22
30	04.353.630	8	04.354.630	12	04.355.630	24
32	04.353.632	8	04.354.632	13	04.355.632	26
34	04.353.634	9	04.354.634	14	04.355.634	28
36	04.353.636	9	04.354.636	14	04.355.636	30
38	04.353.638	10	04.354.638	15	04.355.638	32
40	04.353.640	10	04.354.640	16	04.355.640	34
42	04.353.642	11	04.354.642	17	04.355.642	36
44	04.353.644	11	04.354.644	18	04.355.644	38
46	04.353.646	12	04.354.646	18	04.355.646	40
48	04.353.648	12	04.354.648	19	04.355.648	42
50	04.353.650	13	04.354.650	20	04.355.650	44
55	04.353.655	14	04.354.655	22	04.355.655	49
60	04.353.660	15	04.354.660	24	04.355.660	54
65	04.353.665	16	04.354.665	26	04.355.665	59
70	04.353.670	18	04.354.670	28	04.355.670	64
75	04.353.675	19	04.354.675	30	04.355.675	69
80	04.353.680	20	04.354.680	32	04.355.680	74
85	04.353.685	21	04.354.685	34	04.355.685	79
90	04.353.690	23	04.354.690	36	04.355.690	84
95	04.353.695	24	04.354.695	38	04.355.695	89
100	04.353.600	25	04.354.600	40	04.355.600	94
105	04.353.601	26	04.354.601	42	04.355.601	99
110	04.353.602	28	04.354.602	44	04.355.602	104

Washer – Ø 5.5 mm

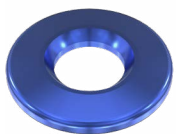

04.353.906.05	Washer For 5.5 Cann Screw + 5pk
04.353.906S	Washer For 5.5 Cann Screw + Sterile

All implants for this diameter are also available sterile packed. Sterile part availability might be different depending on the country or region.

CSS+ Ø 6.5 mm

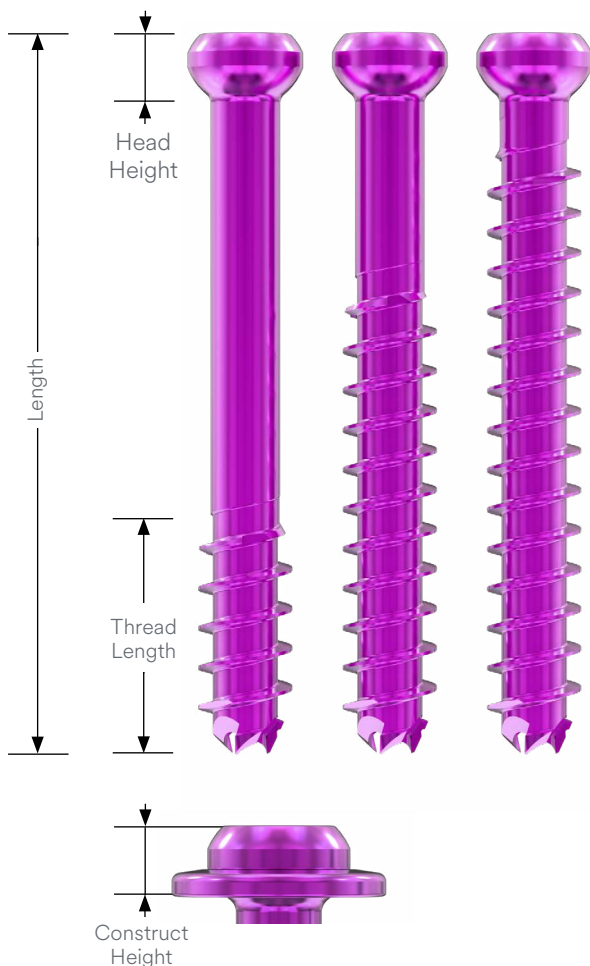

Head Height: 4.45 mm

Washer and Head Construct Height: 3.94 mm

Thread Length

Short Thread = 16 mm Length

Long Thread = 32 mm Length

Full Thread = Total Length minus 8 mm

Washer – Ø 6.5 mm



Length (mm)	Short Thread Part Number	Long Thread Part Number	Full Thread Part Number	Thread Length (mm)
30	04.353.730	N/A	04.355.730	22
35	04.353.735		04.355.735	27
40	04.353.740		04.355.740	32
45	04.353.745	04.354.745	04.355.745	37
50	04.353.750	04.354.750	04.355.750	42
55	04.353.755	04.354.755	04.355.755	47
60	04.353.760	04.354.760	04.355.760	52
65	04.353.765	04.354.765	04.355.765	57
70	04.353.770	04.354.770	04.355.770	62
75	04.353.775	04.354.775	04.355.775	67
80	04.353.780	04.354.780	04.355.780	72
85	04.353.785	04.354.785	04.355.785	77
90	04.353.790	04.354.790	04.355.790	82
95	04.353.795	04.354.795	04.355.795	87
100	04.353.700	04.354.700	04.355.700	92
105	04.353.701	04.354.701	04.355.701	97
110	04.353.702	04.354.702	04.355.702	102
115	04.353.703	04.354.703	04.355.703	107
120	04.353.704	04.354.704	04.355.704	112
125	04.353.705	04.354.705	04.355.705	117
130	04.353.706	04.354.706	04.355.706	122
135	04.353.707	04.354.707	04.355.707	127
140	04.353.708	04.354.708	04.355.708	132
145	04.353.709S	04.354.709S	04.355.709S	137
150	04.353.710S	04.354.710S	04.355.710S	142
155	04.353.711S	04.354.711S	04.355.711S	147
160	04.353.712S	04.354.712S	04.355.712S	152
165	04.353.713S	04.354.713S	04.355.713S	157
170	04.353.714S	04.354.714S	04.355.714S	162
175	04.353.715S	04.354.715S	04.355.715S	167
180	04.353.716S	04.354.716S	04.355.716S	172

■ Sterile Packed Only

04.353.907.05	Washer For 6.5 Cann Screw + 5pk
04.353.907S	Washer For 6.5 Cann Screw + Sterile

All implants for this diameter are also available sterile packed. Sterile part availability might be different depending on the country or region.

CSS+ Ø 7.5 mm

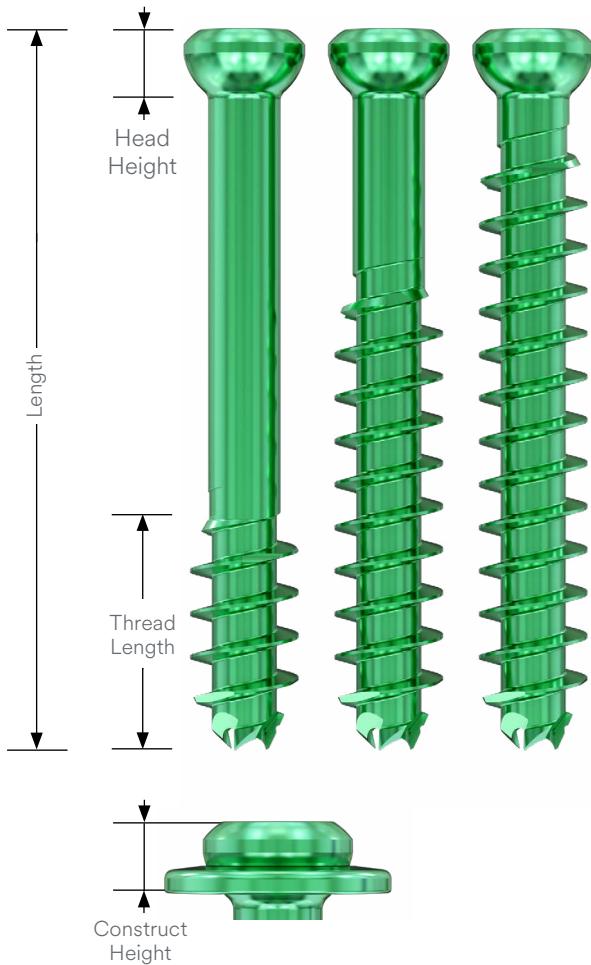

Head Height: 4.50 mm

Washer and Head Construct Height: 3.97 mm

Thread Length

Short Thread = 16 mm Length

Long Thread = 32 mm Length

Full Thread = Total Length minus 8 mm

Washer – Ø 7.5 mm

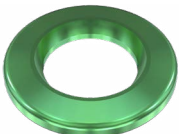

Length (mm)	Short Thread Part Number	Long Thread Part Number	Full Thread Part Number	Thread Length (mm)
30	04.353.830	N/A	04.355.830	22
35	04.353.835		04.355.835	27
40	04.353.840		04.355.840	32
45	04.353.845	04.354.845	04.355.845	37
50	04.353.850	04.354.850	04.355.850	42
55	04.353.855	04.354.855	04.355.855	47
60	04.353.860	04.354.860	04.355.860	52
65	04.353.865	04.354.865	04.355.865	57
70	04.353.870	04.354.870	04.355.870	62
75	04.353.875	04.354.875	04.355.875	67
80	04.353.880	04.354.880	04.355.880	72
85	04.353.885	04.354.885	04.355.885	77
90	04.353.890	04.354.890	04.355.890	82
95	04.353.895	04.354.895	04.355.895	87
100	04.353.800	04.354.800	04.355.800	92
105	04.353.801	04.354.801	04.355.801	97
110	04.353.802	04.354.802	04.355.802	102
115	04.353.803	04.354.803	04.355.803	107
120	04.353.804	04.354.804	04.355.804	112
125	04.353.805	04.354.805	04.355.805	117
130	04.353.806	04.354.806	04.355.806	122
135	04.353.807	04.354.807	04.355.807	127
140	04.353.808	04.354.808	04.355.808	132
145	04.353.809S	04.354.809S	04.355.809S	137
150	04.353.810S	04.354.810S	04.355.810S	142
155	04.353.811S	04.354.811S	04.355.811S	147
160	04.353.812S	04.354.812S	04.355.812S	152
165	04.353.813S	04.354.813S	04.355.813S	157
170	04.353.814S	04.354.814S	04.355.814S	162
175	04.353.815S	04.354.815S	04.355.815S	167
180	04.353.816S	04.354.816S	04.355.816S	172

■ Sterile Packed Only

04.353.908.05	Washer For 7.5 Cann Screw + 5pk
04.353.908S	Washer For 7.5 Cann Screw + Sterile

All implants for this diameter are also available sterile packed. Sterile part availability might be different depending on the country or region.

Instruments

Instruments for 2.0 mm Screws

03.333.000 Guide Wire Ø 0.8 mm, Length 100 mm,
03.333.000S* Trocar Tip



03.333.500 Direct Measuring Device,
for 100 mm Wire



03.333.400 Double Drill Guide, for Ø 1.6 mm Drill Bit
and Ø 0.8 mm Guide Wire



03.333.100 Cannulated Drill Bit Ø 1.6 mm,
03.333.100S* for Quick Coupling, 95 mm



03.333.210 Cannulated Countersink for Ø 2.0 mm
03.333.210S* Cannulated Headed Screw, for Quick
Coupling



03.333.300 T6 Cannulated Stardrive Screwdriver
Shaft/Self-Retaining



03.333.600 Cannulated Screwdriver Handle with
Jewelers Cap/Quick Coupling



*Part numbers with a trailing 'S' designate the sterile part number.
Sterile part availability might be different depending on the country or region.

Optional Instruments for 2.0 mm Screws



03.333.301 T6 Stardrive Screwdriver Shaft/
Self-Retain



319.97 Screw Forceps, Self-Holding,
319.970 Length 85 mm



319.289 1.0 mm Cleaning Brush



319.293 0.8 mm Cleaning Stylet



319.39 Sharp Hook, Length 155 mm
319.390



Instruments for 2.5/3.0 mm Screws ● ●

03.333.001 Guide Wire Ø 1.1 mm, Length 150 mm,
03.333.001S* Trocar Tip



03.333.011 Threaded Guide Wire Ø 1.1 mm, Length
03.333.011S* 150 mm



03.333.501 Direct Measuring Device,
for 150 mm wire



03.333.401 Double Drill Guide, for Ø 2.0 mm Drill Bit
and Ø 1.1 mm Guide Wire



03.333.101 Cannulated Drill Bit Ø 2.0 mm,
03.333.101S* for Quick Coupling, 145 mm



03.333.211 Cannulated Countersink for Ø 2.5 mm
03.333.211S* and 3.0 mm Cannulated Headed Screw,
for Quick Coupling



03.333.302 T8 Cannulated Stardrive Screwdriver
Shaft/Self-Retaining



03.333.600 Cannulated Screwdriver Handle with
Jewelers Cap/Quick Coupling



*Part numbers with a trailing 'S' designate the sterile part number.
Sterile part availability might be different depending on the country or region.

Optional Instruments for 2.5/3.0 mm Screws



03.333.303 T8 Stardrive Screwdriver Shaft/
Self-Retain



319.97 Screw Forceps, Self-Holding,
319.970 Length 85 mm



319.291 1.25 mm Cleaning Brush



319.292 1.1 mm Cleaning Stylet



319.39 Sharp Hook, Length 155 mm
319.390



Instruments for 3.5/4.0 mm Screws ● ●

03.333.002 Guide Wire Ø 1.4 mm, Length 150 mm,
03.333.002S* Trocar Tip



03.333.012 Threaded Guide Wire Ø 1.4 mm, Length
03.333.012S* 150 mm



03.333.501 Direct Measuring Device,
for 150 mm wire



03.333.402 Double Drill Guide, for Ø 2.7 mm Drill Bit
and Ø 1.4 mm Guide Wire



03.333.102 Cannulated Drill Bit Ø 2.7 mm,
03.333.102S* for Quick Coupling, 145 mm



03.333.212 Cannulated Countersink for Ø 3.5 mm
03.333.212S* and 4.0 mm Cannulated Headed Screw,
for Quick Coupling



03.333.304 T15 Cannulated Stardrive Screwdriver
Shaft/Self-Retaining



03.333.306 T15 Stardrive Screwdriver Shaft/
Self-Retaining



03.333.601 Cannulated Screwdriver Handle with
Ratchet Quick Coupling



*Part numbers with a trailing 'S' designate the sterile part number.
Sterile part availability might be different depending on the country or region.

Optional Instruments for 3.5/4.0 mm Screws



319.97 Screw Forceps, Self-Holding,
319.970 Length 85 mm



319.25 1.35 mm Cleaning Brush
319.250



319.38 1.25 mm Cleaning Stylet
319.380



319.39 Sharp Hook, Length 155 mm
319.390



Instruments for 4.5/5.5 mm Screws



03.333.003 Guide Wire Ø 1.6 mm, Length 220 mm,
03.333.003S* Trocar Tip



03.333.013 Threaded Guide Wire Ø 1.6 mm, Length
03.333.013S 220 mm



03.333.502 Direct Measuring Device, for 220 mm



03.333.403 Double Drill Guide, for Ø 3.0 mm Drill Bit
and Ø 1.6 mm Guide Wire



03.333.103 Cannulated Drill Bit Ø 3.0 mm,
03.333.103S* for Quick Coupling, 215 mm



03.333.213 Cannulated Countersink for Ø 4.5 mm
03.333.213S* and 5.5 mm Cannulated Headed Screw,
for Quick Coupling



03.333.304 T15 Cannulated Stardrive Screwdriver
Shaft/Self-Retaining



03.333.306 Solid Screwdriver Shaft T15



03.333.601 Cannulated Screwdriver Handle with
Ratchet Quick Coupling



*Part numbers with a trailing 'S' designate the sterile part number.
Sterile part availability might be different depending on the country or region.

Instruments for 4.5/5.5 mm Screws ● ●

03.333.700 9.5 mm/7.5 mm Tissue Protector



03.333.701 7.5 mm/1.6 mm Guide Wire Sleeve



312.73 Adjustable 1.6 mm Parallel Wire Guide
312.730



Optional Instruments for 4.5/5.5 mm Screws ● ●

03.333.800 Cannulated Tap Ø 4.5 mm,
03.333.800S*



03.333.801 Cannulated Tap Ø 5.5 mm,
03.333.801S*



319.97 Screw Forceps, Self-Holding,
319.970 Length 85 mm



319.26 1.75 mm Cleaning Brush
319.260



319.35 1.6 mm Cleaning Stylet
319.350



319.39 Sharp Hook, Length 155 mm
319.390



*Part numbers with a trailing 'S' designate the sterile part number.
Sterile part availability might be different depending on the country or region.

Instruments for 6.5/7.5 mm Screws ● ●

03.333.004 Guide Wire Ø 2.8 mm, Length 220 mm,
03.333.004S* Fluted Tip



03.333.005 Guide Wire Ø 2.8 mm, Length 300 mm,
03.333.005S* Fluted Tip



03.333.015 Threaded Guide Wire Ø 2.8 mm, Length
03.333.015S* 300 mm



03.333.502 Direct Measuring Device, for 220 mm



03.333.503 Direct Measuring Device, for 300 mm



03.333.404 Double Drill Guide, for Ø 5.0 mm Drill Bit
and Ø 2.8 mm Guide Wire



03.333.104 Cannulated Drill Bit Ø 5.0 mm,
03.333.104S* for Large Quick Coupling, 215 mm



03.333.112 Long Cannulated Drill Bit Ø 5.0 mm, for
03.333.112S Large Quick Coupling, Length 295 mm



03.333.214 Cannulated Countersink for 6.5/7.5 mm
03.333.214S* Headed Cannulated Screw, for Large
Quick Coupling



*Part numbers with a trailing 'S' designate the sterile part number.
Sterile part availability might be different depending on the country or region.

Instruments for 6.5/7.5 mm Screws



03.333.215 Long Cannulated Countersink for
03.333.215S* Ø 6.5 mm and 7.5 mm Cannulated
Headed Screw, for Large Quick Coupling



03.333.305 T30 Cannulated Stardrive Screwdriver
Shaft/Self-Retaining



03.333.310 T30 Stardrive Screwdriver Shaft,
Self-Retaining



03.333.311 T30 Cannulated Stardrive Screwdriver
Shaft/Self-Retaining/Long



03.333.312 T30 Stardrive Screwdriver Shaft/
Self-Retaining/Long



03.333.602 Cannulated Screwdriver Handle with
Ratchet Large Quick Coupling



03.333.702 11.0 mm/9.0 mm Tissue Protector



03.333.703 9.0 mm/2.8 mm Guide Wire Sleeve



*Part numbers with a trailing 'S' designate the sterile part number.
Sterile part availability might be different depending on the country or region.

Instruments for 6.5/7.5 mm Screws ● ●

03.333.706 11.0 mm/9.0 mm Tissue Protector Long



03.333.707 9.0 mm/2.8 mm Guide Wire Sleeve Long



03.333.710 Handle for Guides



03.333.711 2.8 mm Adjustable Parallel Wire Guide



03.333.712 2.8 mm Multiple Wire Guide

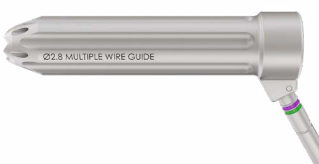

03.333.713 Multiple Wire Guide Trocar



338.49 Large Quick Coupling
338.490



Optional Instruments for 6.5/7.5 mm Screws



03.333.016S* Threaded Guide Wire Ø 2.8 mm,
Length 450 mm, Sterile



03.333.006S* Guide Wire Ø 2.8 mm, Length 450 mm,
Fluted Tip, Sterile



03.333.113S* Long Cannulated Drill Bit Ø 7.5 mm, for
Large Quick Coupling, Length 295 mm,
Sterile



03.333.802 Cannulated Tap Ø 6.5 mm
03.333.802S*



03.333.803 Cannulated Tap Ø7.5 mm
03.333.803S*



03.333.804 Long Cannulated Tap Ø 6.5 mm,
03.333.804S* Length 295 mm



03.333.805 Long Cannulated Tap Ø 7.5 mm,
03.333.805S* Length 295 mm



319.97 Screw Forceps, Self-Holding,
319.970 Length 85 mm



319.24 2.9 mm Cleaning Brush
319.240



319.46 2.8 mm Cleaning Stylet
319.460



319.39 Sharp Hook, Length 155 mm
319.390



*Part numbers with a trailing 'S' designate the sterile part number.
Sterile part availability might be different depending on the country or region.

Set Lists

Instrument and Implant Set – CSS+ Small (01.333.201)

2.0 CSS+

2.5/3.0 CSS+

3.5/4.0 CSS+

Instrument and Implant Set – CSS+ Medium (01.333.202)

4.5/5.5 CSS+

Instrument and Implant Set – CSS+ Large (01.333.203)

6.5/7.5 CSS+

Instrument and Implant Set – CSS+ Large Long Instruments (01.333.204)

6.5/7.5 CSS+

MRI Information

Non-clinical testing has demonstrated the DePuy Synthes Screws are MR Conditional. A patient with these devices can be safely scanned in an MRI system meeting the following conditions:



- Static magnetic field of 3.0 T or 1.5 T
- Maximum spatial field gradient of 1900 gauss/cm (19 T/m)
- Maximum MRI system reported, whole body averaged specific absorption rate (SAR) of 1.0 W/kg

Under the scan conditions defined above, non-clinical testing results indicate the DePuy Synthes Screws are expected to produce a maximum temperature rise of 8 °C after 10 minutes of continuous scanning.

In non-clinical testing, the image artifact caused by the device extends approximately 20 mm from the DePuy Synthes Screw when imaged with a gradient echo pulse sequence and a 3.0 T MRI system.

Limited Warranty and Disclaimer: DePuy Synthes products are sold with a limited warranty to the original purchaser against defects in workmanship and materials. Any other express or implied warranties, including warranties of merchantability or fitness, are hereby disclaimed.

Please also refer to the package insert(s) or other labeling associated with the devices identified in this surgical technique for additional information.

CAUTION: Federal Law (USA) restricts these devices to sale by or on the order of a physician.

Some devices listed in this technique guide may not have been licensed in accordance with Canadian law and may not be for sale in Canada. Please contact your sales consultant for items approved for sale in Canada.

Not all products may currently be available in all markets. Data available on request. Please contact your DePuy Synthes Representative for more information. Please refer to the instruction for use for a complete list of indications, contraindications, warnings and precautions. The Cannulated Compression Headless Screw (CCHS) Instruction for Use is available at cssplus.info. For DePuy Synthes general instruments Instruction for Use please consult for US www.e-ifu.com and for EMEA www.depuyssynthes.com/ifu. All surgical techniques are available as PDF files at www.depuyssynthes.com



Manufactured or distributed by:

Synthes USA Products, LLC

1302 Wrights Lane East
West Chester, PA 19380
(USA)

Synthes USA, LLC

1101 Synthes Avenue
Monument, CO 80132
(USA)

Synthes GmbH

Luzernstrasse 21
4528 Zuchwil
Switzerland

Synthes GmbH

Eimattstrasse 3
4436 Oberdorf
Switzerland

Tyber Medical LLC

83 South Commerce Way, Suite 310
Bethlehem, PA 18017
(USA)

www.tybermedical.com

To order (USA): 800-523-0322
To order (Canada): (844)-243-4321

Note: For recognized manufacturer, refer to the product label.

www.depuyssynthes.com