

Table of contents

Introduction	2
TRIGEN° META-TAN Nail specifications	3
Surgical technique	4
Patient positioning	4
Opening the proximal femur	5
Incision and entry point	5
Entry portal acquisition	6
Intramedullary reaming	8
Fracture reduction	8
Implant measurement	9
Preparing the canal	9
Nail assembly	10
Verifying targeting accuracy	11
Insertion	11
Nail anteversion	11
Insertion depth	12
Proximal locking	13
Standard femoral locking	13
Proximal (integrated screw mode)	14
Integrated Screw insertion	16
Integrated Screw insertion: no compression	18
Integrated Screw insertion: with compression	19
Locking the Cannulated Set Screw (optional)	20
Nail Cap Insertion without set screw (optional)	20
Distal locking	21
Implant removal: optional	22
Catalog information	25

Nota Bene

The technique description herein is made available to the healthcare professional to illustrate the author's suggested treatment for the uncomplicated procedure. In the final analysis, the preferred treatment is that which addresses the needs of the specific patient.

Introduction

The TRIGEN[®] META-TAN[®] Trochanteric Antegrade Nail is indicated for fractures of the femur including simple long bone fractures, severely comminuted, spiral, large oblique and segmental fractures; nonunions and malunions; polytrauma and multiple fractures; prophylactic nailing of impending pathologic fractures; reconstruction, following tumor resection and grafting; supracondylar fractures; bone lengthening and shortening; and for fixation of fractures that occur in and between the proximal third and distal fourth of the femur.

In addition, TRIGEN META-TAN Nails contain holes/slots proximally to accept screws that thread into the femoral head for compression and rotational stability and are indicated for the following: subtrochanteric fractures; intertrochanteric fractures; ipsilateral femoral shaft/neck fractures; and intracapsular fractures.



TRIGEN[◇] META-TAN[◇] Nail Specifications

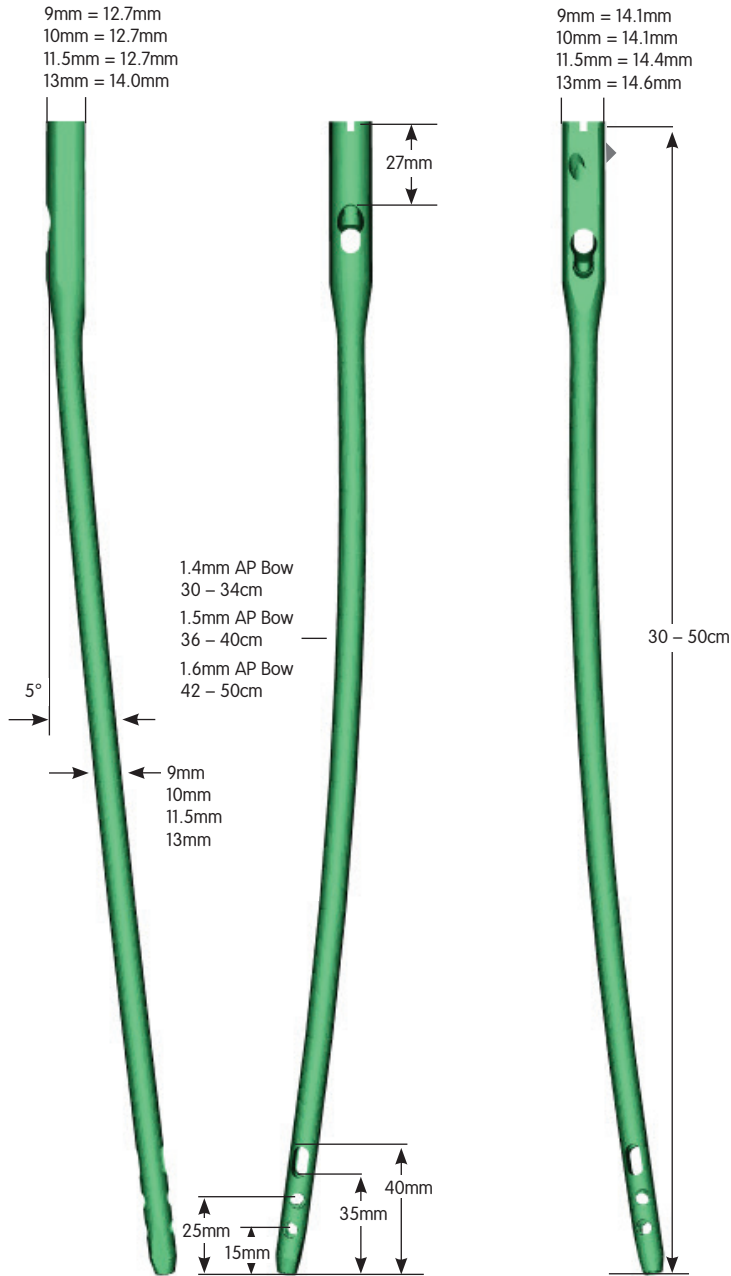

(Integrated screw mode)

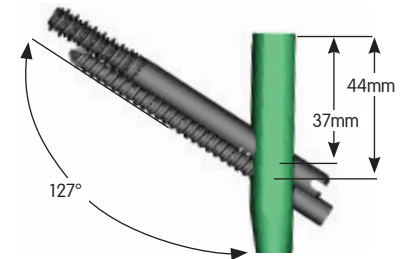

(Femoral locking mode)

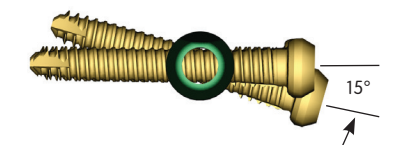
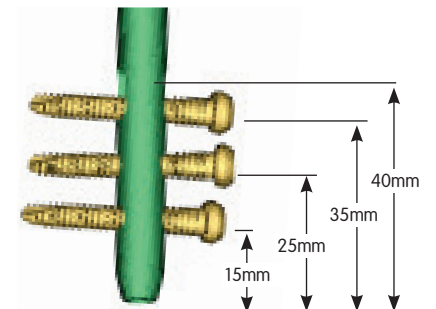
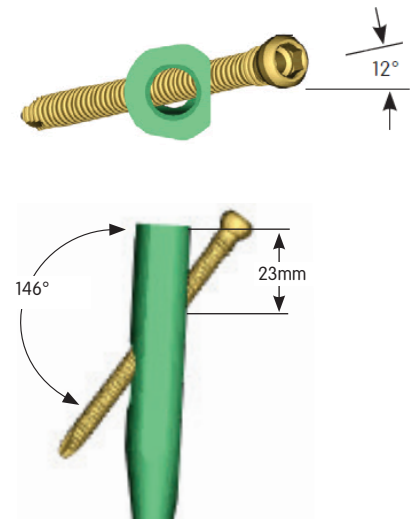

Lag and Compression Screws

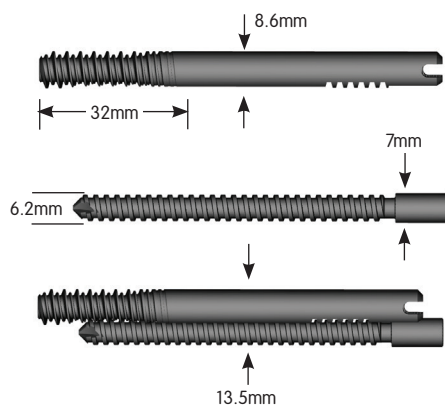

Surgical technique

Patient positioning

Place the patient in the supine or lateral decubitus position on a fracture table. The foot of the affected limb is placed in a foot holder or a pin is inserted through the calcaneus for traction purposes. The unaffected limb is extended below and away from the affected limb or flexed and placed in a leg holder. Check the affected limb for length and rotation by comparison to the unaffected limb. Abduct the torso 10°-15° to allow clear access to the intramedullary canal. Rotate the C-Arm to ensure optimal AP and lateral visualization of the entire femur.

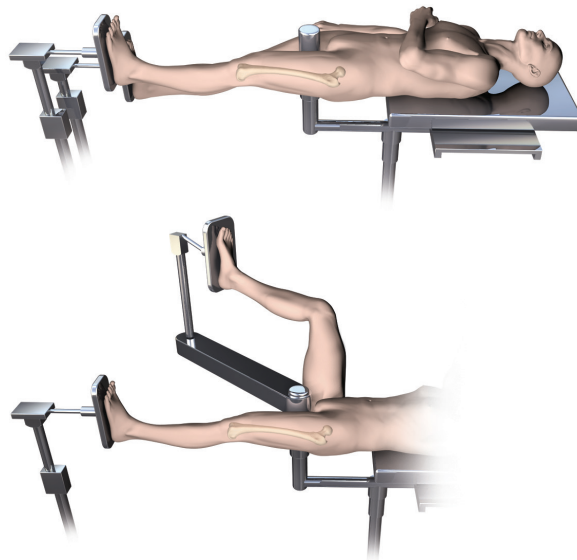

Note If using a radiolucent table, a distraction device may be helpful in reducing the fracture.

Opening the proximal femur

Incision and entry point

Assemble the Honeycomb (7167-4075), Entry Portal Handle (7167-4092) and Entry Portal Tube (7167-4060). The pieces will lock in place securely at either 0° or 180°.

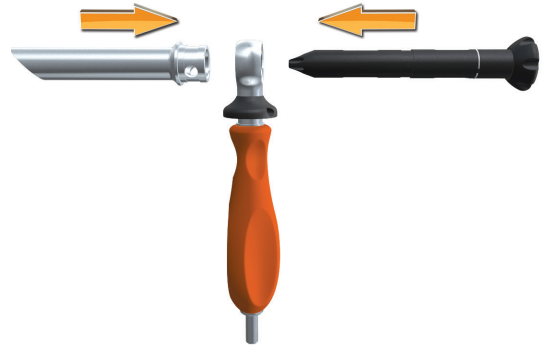

A longitudinal incision is made proximal to the greater trochanter. Carry the incision through to the fascia and palpate the tip of the greater trochanter.

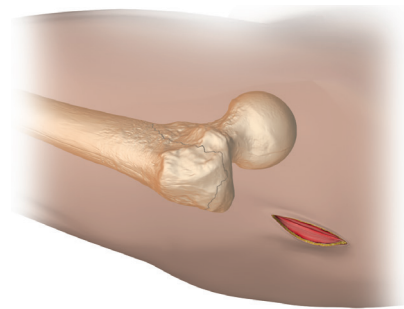

The optimal entry point for the TRIGEN[®] META-TAN[®] nail is located on the medial face of the greater trochanter, 5° from the anatomical axis in the AP and in-line with the intramedullary canal in the lateral view.

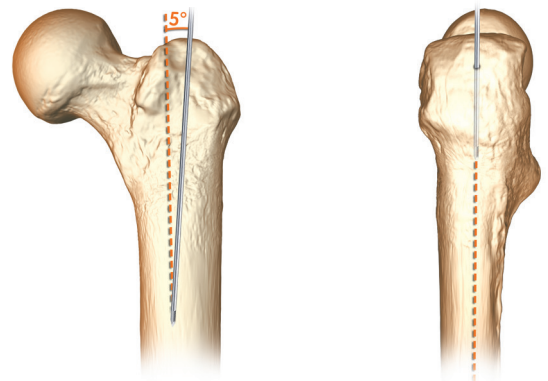

Entry portal acquisition

Insert the Entry Portal Instrumentation through the incision down to bone. Attach a 3.2mm Guide Pin (7163-1436) to power via the Mini Connector (7163-1186) and insert 2 – 3cm into the trochanteric region. Avoid over-insertion of the Guide Pin as this can establish a false trajectory and lead to fracture malalignment. Confirm Guide Pin placement in the AP and lateral planes.

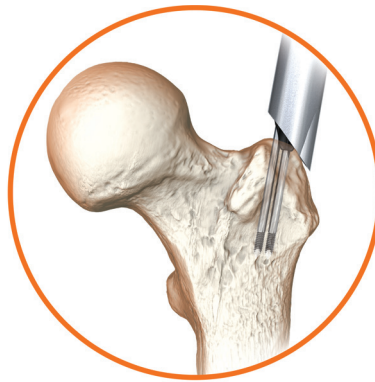
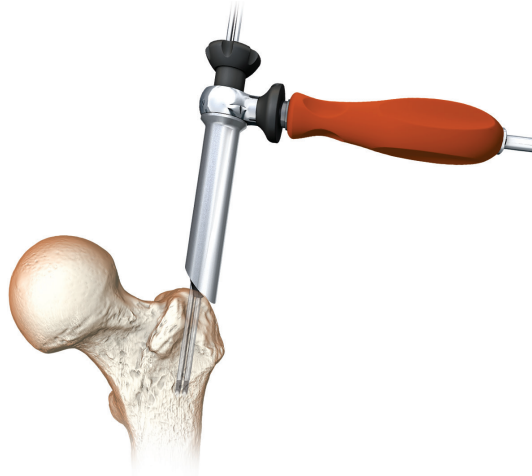
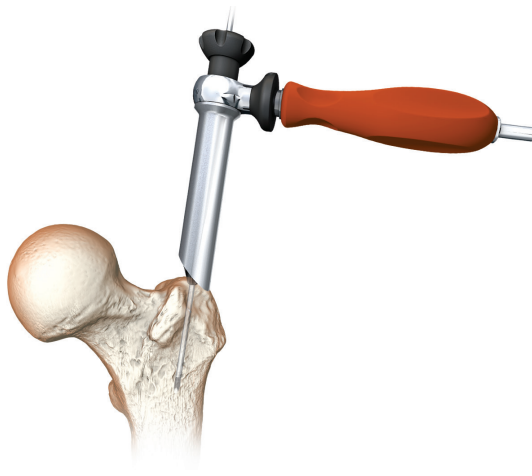

Note In the instance of suboptimal Guide Pin placement, rotate the Honeycomb within the Entry Portal Tube to the desired location and insert another 3.2mm Guide Pin.

Following Guide Pin placement, remove the Honeycomb from the Entry Portal Tube along with any additionally inserted Guide Pins. Insert the 12.5mm Entry Reamer (7163-1116) into the 14mm or 15mm Channel Reamer (7163-1039 or 7163-1445) until it clicks and attach to power. Advance the assembly through the Entry Portal Instrumentation 2 – 3cm into the trochanteric region. Evaluate reamer position before proceeding.

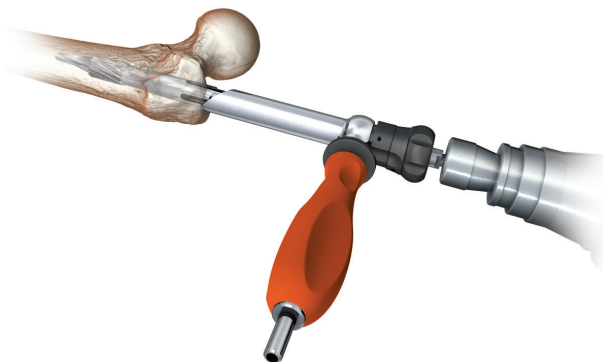

Adjust the trajectory of the reamer assembly if desired and advance to the positive stop on the Entry Portal Tube. The will stop just below the level of the lesser trochanter. If the Entry Portal Instrumentation is not used, the Channel Reamer must still be advanced to the same point. Confirm the reamer assembly's final position in both the AP and lateral planes. Detach and remove the 12.5mm Entry Reamer from the 14mm or 15mm Channel Reamer.

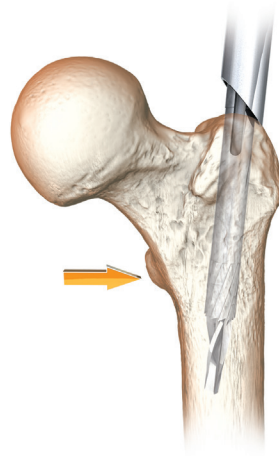

Note The Channel Reamer and Entry Portal Instrumentation will serve as a soft tissue protector.

**Alternative Technique:
Entry Portal Acquisition**

Attach the T-Handle (7167-4076) to the Cannulated Awl (7167-4000) and insert the 3.2mm Trocar (7167-4074) into the back of the assembly. Introduce the awl into the proximal femur at the designated entry point until it is below the level of the lesser trochanter. Remove the 3.2mm Trocar and pass a 3.0mm Ball Tip Guide Rod (7163-1626) into the back of the T-Handle. Remove the awl from the proximal femur.

The region of the proximal femur extending to the lesser trochanter must be enlarged to 14mm in order to accommodate the proximal geometry of a 9mm, 10mm, and 11.5mm META-TAN® Nail. The 13mm nail requires the proximal femur to be enlarged to 15mm.

Note Intramedullary reamers should be used to prepare the proximal femur if the 14mm or 15mm Channel Reamer is not used*.



*The largest Reamer Head that the TRIGEN® Base Instrument Tray can hold is 16mm. Larger sizes are available in the SculptOR Reamer System (7111-8330)

Intramedullary reaming

Fracture reduction

Insert the back end of the 3.0mm Ball Tip Guide Rod (7163-1626) into the front end of the Gripper (7167-4080) and gently close the trigger grip. Connect the Reducer and Reducer Connector (7167-4077) so that the words "Slot Orientation" are in line with the opening at the tip. Complete the Reducer assembly by connecting it to the T-Handle (7167-4076).



Introduce the Reducer into the intramedullary canal through the Channel Reamer and Entry Portal Instrumentation. Care should be taken to maintain fracture reduction. Pass the ball tip guide rod through the back of the T-Handle and insert to the desired depth using the Reducer's curved tip to avoid any areas of comminution. The guide rod should be center-center in the AP and lateral views.

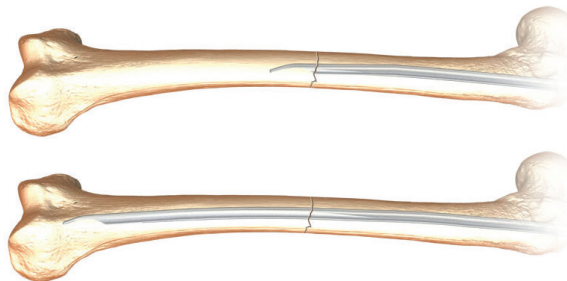

Once the guide rod is in position, detach the Gripper and remove the Reducer from the intramedullary canal. Slide the Obturator (7167-4078) into the back of the T-Handle during extraction in order to maintain guide rod position within the canal.

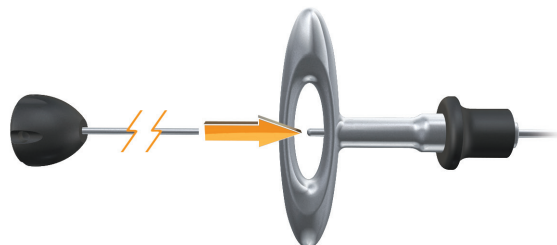

Implant measurement

After Reducer removal, re-confirm guide rod position in the distal femur. Advance the Ruler (7167-4079) over the guide rod through the Channel Reamer and Entry Portal Instrumentation to the desired depth. The bottom of the Ruler's metal tip denotes the driving end of the nail.

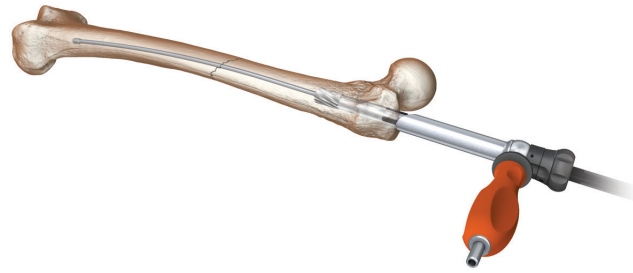

Note Fractures should be treated with the longest nail possible in order to reduce the likelihood of stress risers.

Confirm guide rod position in the window at the proximal end of the Ruler as shown in order to ensure accurate implant measurement. Push down on the top of the Ruler until contact is made with the guide rod. Implant length is read from the exposed calibrations near the thumbwheel on the Ruler.



Note Resistance on the Ruler may be adjusted by tightening or loosening the thumbwheel.

Preparing the canal

Beginning with the 9.0mm End Cutting Reamer Head (7111-8231*) and Flexible Reamer Shaft (7111-8200), ream the intramedullary canal sequentially in half millimeter increments to a size 1-1.5mm larger than the selected nail diameter**.

Ensure guide rod position during reaming by inserting the Obturator into the back of the reamer unit during retraction. Continue to confirm guide rod position throughout reaming. Periodically move the reamer back and forth in the canal to clear debris from the cutting flutes.

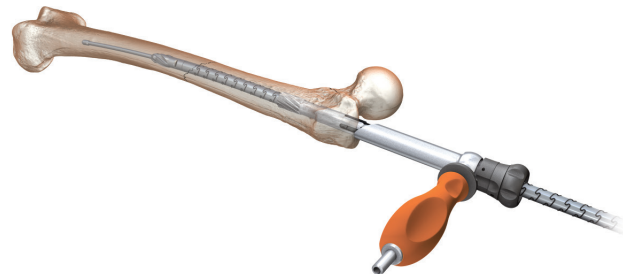

Note The Channel Reamers will not accommodate reamer heads larger than 12.5mm.

*Not included in the TRIGEN Reamer Set (7167-1212). Available in the SculptOR(diamond) Reamer Set (7111-8330).

**The largest Reamer Head that the TRIGEN® Base Instrument Tray can hold is 16.0mm. Larger sizes are available in the SculptOR® Reamer Set (7111-8330).

Nail assembly

Attach the Drill Guide (7163-1451) to the nail with the Guide Bolt (7163-1024) and tighten with the Guide Bolt Wrench (7163-1140) and T-Handle. The nail can only be attached to the Drill Guide in one way.



Verifying targeting accuracy

1. **Femoral locking mode:** Insert a 9.0mm Drill Sleeve (7163-1152) and 4.0mm Drill Sleeve (7167-4083) into the Drill Guide. Pass a 4.0mm Long Pilot Drill (7163-1110)* through the drill sleeves and nail.
2. **Integrated screw mode:** Attach the Drill Guide Drop (7163-1452) to the Drill Guide to verify targeting accuracy. Insert the Lag Screw Drill Sleeve (7163-1418) into the Drill Guide Drop. Pass the Lag Screw Drill (7163-1432) through the Lag Screw Drill Sleeve and nail.

An incorrectly attached nail will not target. With targeting accuracy confirmed, remove the drop and any drill sleeves.

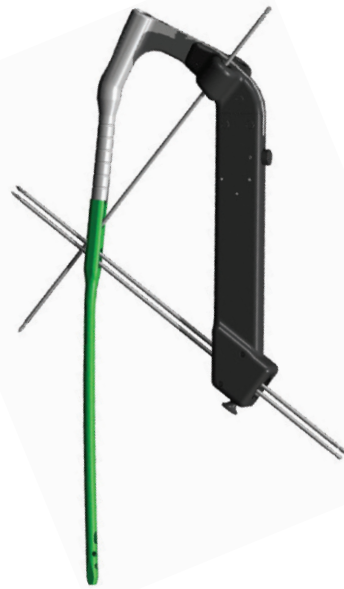

Insertion

Orient the Drill Guide in the lateral position and manually advance the nail into the proximal femur.

Note Do not definitively seat the nail until femoral neck anteversion has been determined. Further insertion of the nail may be required to adequately seat the implant.

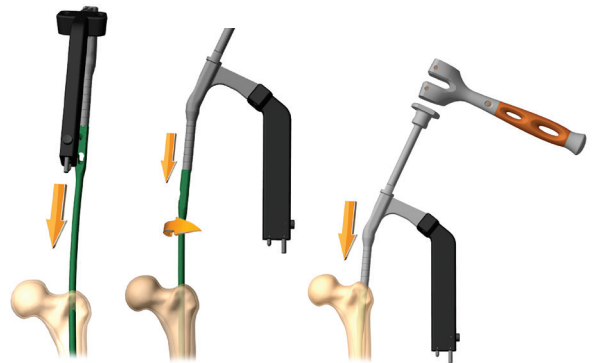

Nail anteversion

Begin insertion with the Drill Guide in the AP plane. As the nail taper reaches the isthmus of the canal, rotate the handle to the lateral position.

With the C-Arm in the lateral position, rotate the drill guide until it transects the nail and is center-center in the femoral neck and head.

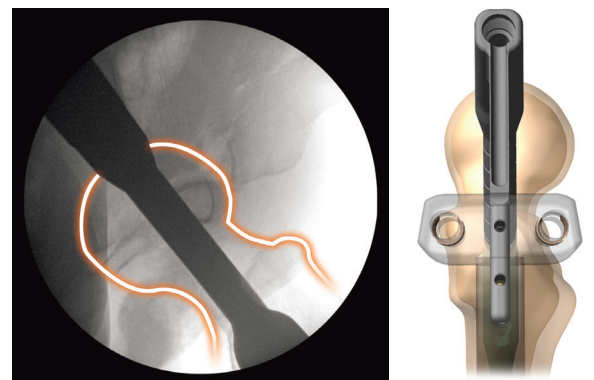

*4.0mm Long Pilot Drill (7163-1110) is interchangeable with 4.0mm AO Long Drill (7163-1121).

Insertion depth

Proximal

Insert the nail until its driving end is at or below the top of the greater trochanter. Each gauge on the insertion barrel represents a 10mm depth interval.



Proximal locking

Standard femoral locking

Slide the 4.0mm Drill Sleeve (7167-4083) and insert into a 9.0mm Drill Sleeve. Make a small incision at the site of screw entry and insert the sleeve assembly through the hole on the drill guide and down to bone. Attach the 4.0mm Long Pilot Drill* to power via the Mini Connector, remove the trocar from the drill sleeve assembly and drill both cortices.

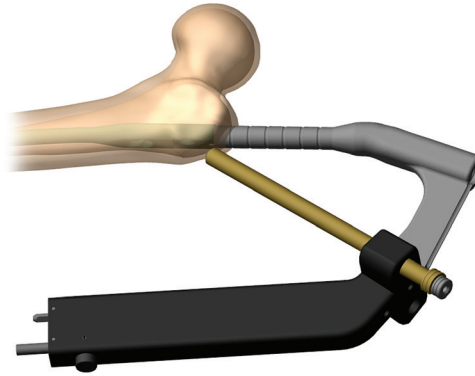

Measure for screw length using either the calibrations on the 4.0mm Long Pilot Drill or by removing the Drill Sleeve and using the Screw Depth Gauge (7163-1189).

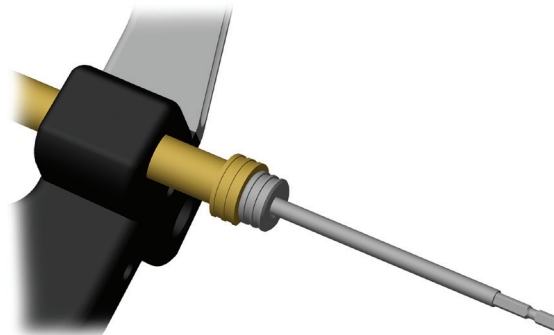

Note The 4.0mm Drill Sleeve must be against the lateral cortex for accurate locking screw length measurement.

Attach the appropriate length 5.0mm locking screw to the end of the Medium Hexdriver (7163-1066) and insert through the 9.0mm Drill Sleeve on power until the laser etched ring on the hexdriver reaches the back of the drill sleeve. Attach the T-Handle to the hexdriver and tighten the locking screw by hand.

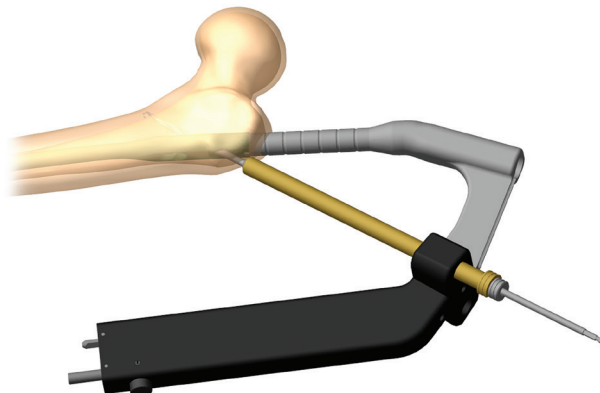

* 4.0mm AO Long Drill (7163-1121) is interchangeable with 4.0mm Long Pilot Drill (7163-1110)

Proximal (integrated screw mode)

Integrated screw mode

Attach the alignment tower to the drop and slide the back end of the alignment arm into the tower. The Alignment Arm represents the location of both lag and compression screws prior to insertion.

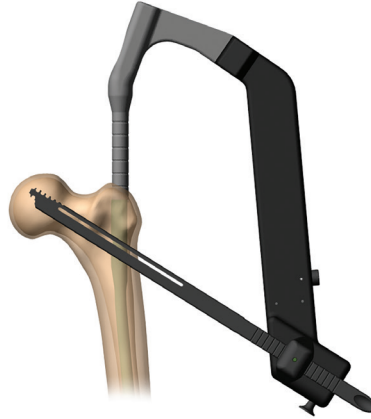

Note: Verify the position of the Alignment Arm under fluoroscopy with the C-arm in the AP and the emitter parallel to the top surface of the Alignment Arm.



The radiolucent slot in the center of the arm should be center-center in the femoral neck and head. This represents the central axis of the Integrated Interlocking Lag Screw. The compression screw sits beneath the Lag Screw in the Integrated Screw formation. Definitely seat the nail using the Slotted Hammer. Remove the Impactor from the Drill Guide Handle and the 3.0mm Ball Tip Guide Rod from the intramedullary canal if used.

Distal

Verify center-center placement of the nail in the distal femoral metaphysis in both the AP and lateral planes.

Note Remove the 3.0mm Ball Tip Guide Rod.

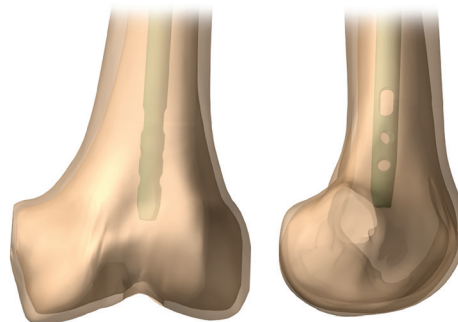

Lag Screw Drill Sleeve insertion

Make an incision at the site of Lag Screw entry and insert the Lag Screw Drill Sleeve (7163-1418) into the Drill Guide Drop until it locks.



Insert the Guide Pin sleeve (7163-1426) and advance the 3.2mm Guide Pin into the femoral head. It is recommended that a new Guide Pin be used at this point in the technique. Confirm Guide Pin position in both the AP and lateral planes. The Guide Pin should be center-center in both views with a Tip-Apex Distance of less than 25mm*.

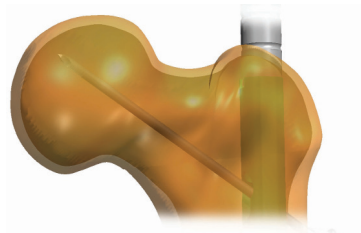
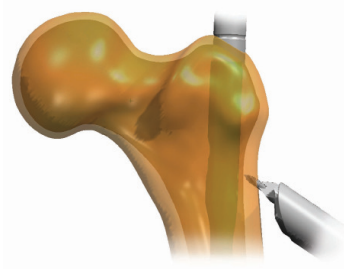

Lag Screw measurement

Slide the Lag Screw Length Gauge (7167-4558) under the 3.2mm Guide Pin to the back of the Lag Screw drill sleeve. Lag Screw length is taken at the end of the Guide Pin.

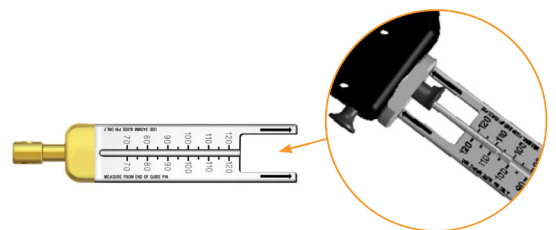

*The Value of the Tip-Apex distance in predicting failure of fixation of peritrochanteric fractures of the hip. MR Baumgaertner, SL Curtin, DM Lindskog and JM Keggi. The Journal of Bone and Joint Surgery of America, 77: pp.1058-1064, 1995.

Integrated screw insertion

Confirm Guide Pin position. Attach the Compression Screw Starter Drill (7163-1448) to power and insert into the Lag Screw Drill Sleeve beneath the 3.2mm Guide Pin. Advance the starter drill under power until it abuts with the back end of the Lag Screw Guide Pin Sleeve.



Attach the Compression Screw Drill (7163-1428) to power and insert through the Lag Screw Drill Sleeve into the hole created by the starter drill. Advance the compression screw drill under fluoroscopy to a depth 5mm less than the measurement taken from the guide pin. The markings on the Compression Screw Drill are read off the back of the Lag Screw Drill Sleeve.



Remove the Compression Screw Drill and manually insert the Anti-Rotation Bar (7163-1434) into the same hole. If the Anti-Rotation Bar meets with resistance upon insertion, remove it and re-drill with the Compression Screw Drill.

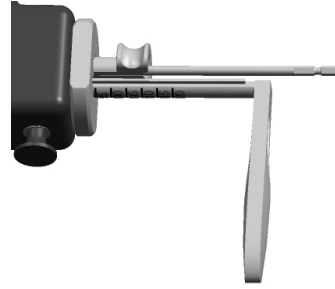

Confirm Guide Pin position and remove the Guide Pin Sleeve. Attach the Lag Screw Drill to power and insert into the Lag Screw Drill Sleeve over the 3.2mm Guide Pin. Drill to the depth measured for the Lag Screw. The calibrations are read off the back of the drill sleeve. Confirm the Lag Screw Drill tip position under fluoroscopy.

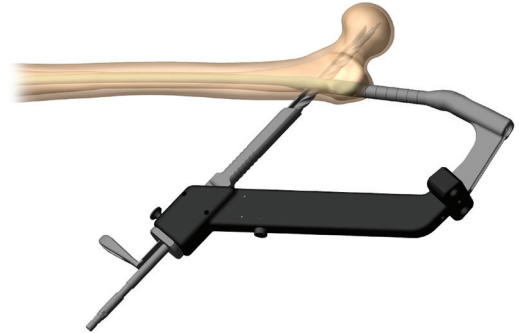

Note In the instance of hard bone, it may be necessary to use the Lag Screw Tap (7163-1450) prior to Lag Screw insertion.



Integrated screw insertion: no compression

Select a Lag Screw equal in length to the drilled depth.

Example Drilling depth 100mm
 Screw length 100mm

Align the back end of the appropriate length Interlocking Lag Screw with the Lag Screwdriver. Thread the retaining rod into the Lag Screw and tighten. Insert the assembly into the Lag Screw Drill Sleeve over the 3.2mm Guide Pin.

Advance the Lag Screw manually until the "0mm" mark on the Lag Screwdriver is flush with the back of the Lag Screw Drill Sleeve and the T-Handle is perpendicular to the Drill Guide Drop. The groove on the undersurface of the Lag Screwdriver must be oriented towards the patient's feet in order to remove the Anti-Rotation Bar.

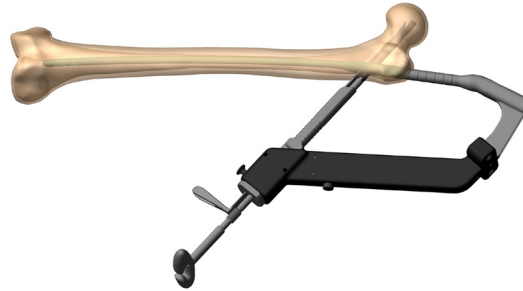

Remove the Anti-Rotation Bar and attach the compression screw that was packaged with the Lag Screw to the Compression Screw Hexdriver (7163-1444). Attach the T-Handle to the screw hexdriver and insert the assembly into the Lag Screw Drill Sleeve beneath the Lag Screwdriver. Advance the compression screw until the blue line on the hexdriver is flush with the back of the Lag Screw Drill Sleeve.



Integrated screw insertion: with compression

Select a Lag Screw equal in length to the drilled depth minus the desired amount of compression.

Example	Drilling depth	100mm
	Compression	5mm
	Screw length	95mm

Align the back end of the appropriate length Integrated Interlocking Lag Screw with the Lag Screw Driver. Thread the Retaining Rod into the Lag Screw and tighten. Insert the assembly into the Lag Screw Drill Sleeve over the 3.2mm Guide Pin.

If compression is desired, advance the Lag Screw manually until the “5mm” or “10mm” mark on the Lag Screw Driver is flush with the back of the Lag Screw Drill Sleeve. At final seating, the handle must be perpendicular to the drill guide assembly. The groove on the under-surface of the Lag Screw Driver must be oriented towards the patient’s feet in order to remove the Anti-Rotation Bar. Release any traction on the affected limb to allow for fracture compression.

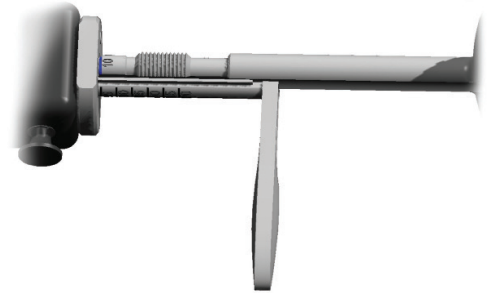

Remove the Anti-Rotation Bar and attach the compression screw that was packaged with the Lag Screw to the Compression Screw Hexdriver. Attach the T-Handle to the screw hexdriver and insert the assembly into the Lag Screw Drill Sleeve beneath the Lag Screw Driver. Advance the compression screw until the blue line on the hexdriver is flush with the back of the Lag Screw Drill Sleeve.

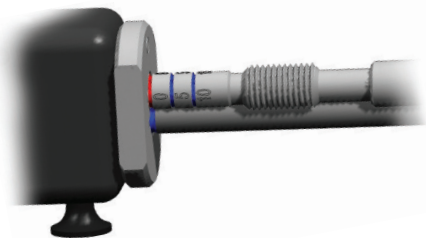

Compression is achieved by advancing the compression screw assembly clockwise until the “0mm” mark on the Lag Screw Driver is visible. As the head of the compression screw abuts within the nail, the gear mechanism of the Integrated Screws will compress the fracture. It is recommended to stop compression when the “0mm” mark appears at the red line.

Note A positive stop is located on the Compression Screw Driver to prevent compression past the red line. It is not recommended to compress past the red line.

Integrated screw insertion: locking the Cannulated Set Screw (Optional)

The Integrated Screws are incapable of excessive medial migration and/or rotation within the nail, but can still slide to allow postoperative compression. To facilitate sliding insert the Set Screw until it stops and back it out a ¼ turn.

The Integrated Screws can be locked if post operative sliding is undesirable. Full engagement of the Set Screw with the Lag Screw converts the construct into a fixed angle device.

To lock the Set Screw, remove the Drill Guide Handle and Guide Bolt. Choose a Set Screw and attach it to the Compression Screw Driver or Medium Hexdriver. Attach the Compression Screw Driver to the T-Handle. Turn clockwise to engage the Set Screw with the Integrated Lag Screw. The Set Screws also act as 0mm, 5mm, and 10mm Nail Caps (See below).



Nail Cap insertion without Set Screw (optional)

The standard TRIGEN Nail Caps can also be inserted if the standard proximal femoral locking option is used or if a Nail Cap is desired without a Set Screw in the proximal integrated screw locking option. The Set Screws cannot be used if the standard proximal locking option is chosen.

Distal locking

Long nail: 30cm–50cm

Distal locking is performed in the lateral plane using a free-hand technique. Reconfirm fracture reduction and align the C-Arm over the desired locking hole. Obtain a “perfect circle” image of the locking hole and use a blunt object to approximate the location of the locking hole by dimpling the skin.

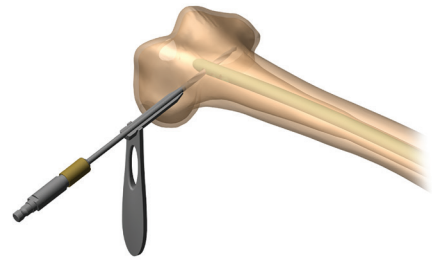

Make a stab incision at the site of screw entry, insert the 4.0mm Short Drill (7163-1123)* down to bone, and drill both cortices. Measure for screw length using the Screw Depth Gauge. Alternatively, leave the 4.0mm Short Drill in place, insert the Screw Length Sleeve (7167-4085) down to bone, and read the exposed calibrations off the drill. Insert the appropriate length 5.0mm locking screw using either the Medium or Short Hexdriver (7163-1066 or 7163-1068) and T-Handle.

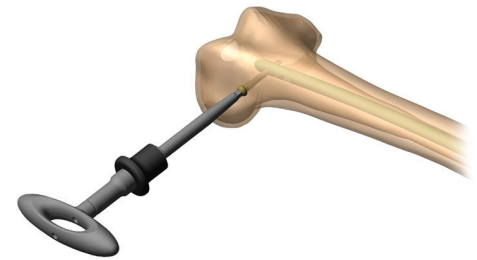

*4.0mm AO Short Drill (7163-1123) is interchangeable with 4.0mm Short Drill (7163-1117)

Implant removal: optional

Disengage the Cannulated Set Screw or TRIGEN® Nail Cap

Remove the Cannulated Set Screw or TRIGEN Nail Cap if implanted using the Medium Hexdriver or Compression Screw Driver and T-Handle. Attach the Medium Hexdriver or Compression Screw Driver to the T-Handle and insert into the top of the nail until it engages with the hex of the Cannulated Set Screw or TRIGEN Nail Cap. Turn counterclockwise to fully disengage.



Integrated screws removal

Insert the Compression Screw Hexdriver into the back of the Compression Screw and engage the retaining rod. Attach the T-Handle to the back of the hexdriver and remove using counterclockwise turns of the assembly.

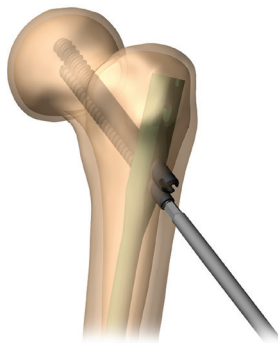

Under fluoroscopy, insert a 3.2mm Guide Pin into the back of the Integrated Interlocking Lag Screw. Slide the Lag Screw Driver over the Guide Pin and engage it with the back of the Lag Screw. Thread the retaining rod into the Lag Screw and remove using counterclockwise turns of the assembly.

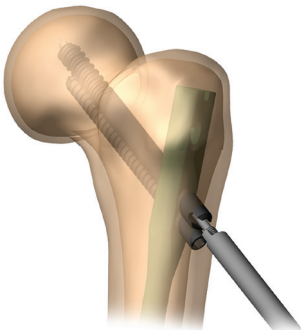

Implant removal: optional

Open nail extraction technique

Remove the Nail Cap or Cannulated Set Screw if implanted and all but one of the locking screws using the Medium Hexdriver and T-Handle. Thread the Nail Extractor (7163-1278) into the Impactor and introduce the extraction assembly into the top of the nail. Remove the final locking screw(s) and extract the nail with a back-slapping motion using the Slotted Hammer.

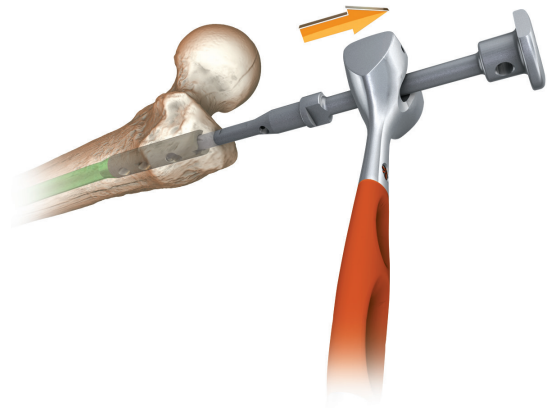

Percutaneous nail extraction technique

This technique assumes the absence of a Nail Cap. Attach a 3.2mm x 343mm Tip Threaded Guide Pin to power via the Mini Connector and insert into the top of the nail under fluoroscopy. This may also be performed manually.

Attach the 12.5mm Entry Reamer to power. Make a one inch incision around the Guide Pin and advance the entry reamer over the Guide Pin and into the top of the nail to remove bony in-growth. Nail extraction follows the previously described technique.

Note The tip of the entry reamer is straight for approximately one inch before flaring out. It is this portion of the entry reamer that enters the top of the nail.

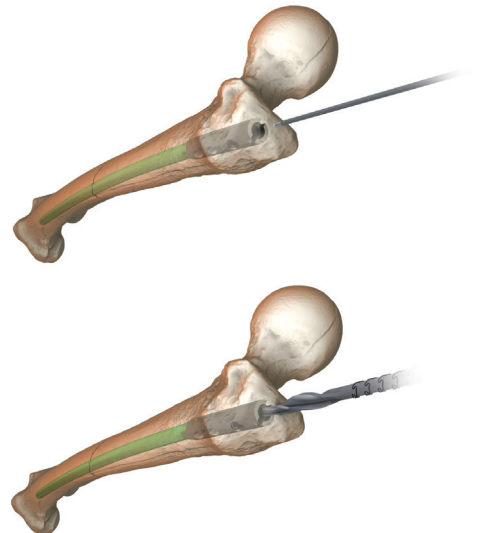

Guide rod jamming technique

Advance the end of a 3.0mm Ball Tip Guide Rod (7163-1626) through the end of the nail. Insert a 2.0mm Ball Tip Guide Rod (7175-1146) driving the non-ball end through the top of the nail. With both Guide Rods in place attach the Gripper to the end of the 3.0mm Ball Tip Guide Rod and pull it back so that it wedges the ball tip against the 2.0mm Ball Tip Guide Rod. Backslap against the Gripper with the Slotted Hammer to extract the nail.

Guide Rods

Cat. No.	Description
7175-1147	2.0mm x 600mm Ball Tip
7163-1626	3.0mm x 1000mm Ball Tip

Additional removal items

Cat. No.	Description
115074	Large Extractor Hook**
115073	Small Extractor Hook**

* Available sterile. For nail removal only, do not use for nail insertion

** Located in Russell-Taylor Extraction Kit (Set #7508) available through Loaners

Catalog information

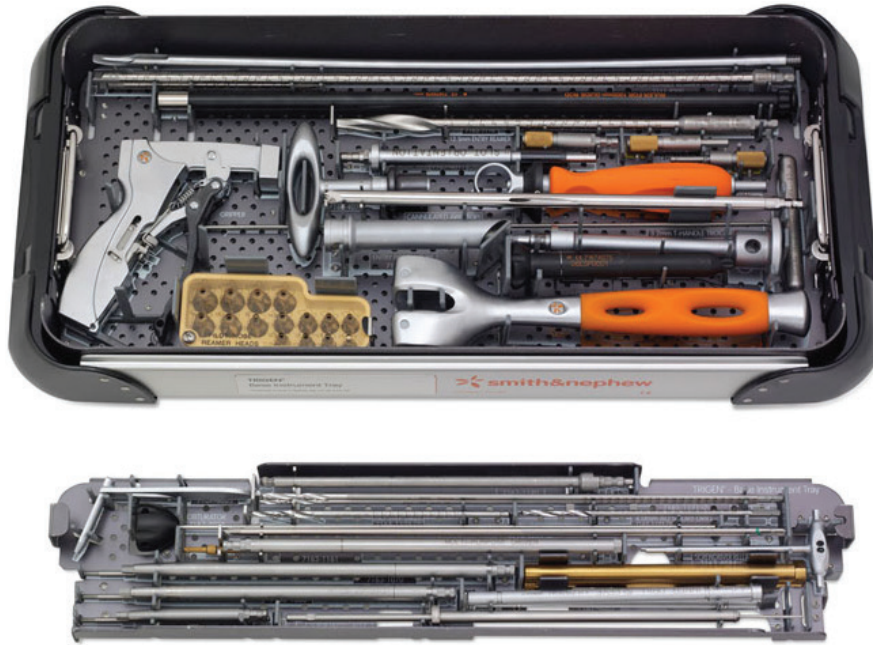

TRIGEN® Base Instrument Set*

Set No. 7167-4012

Instrument Case

Cat. No.	Description	Qty
7112-9401	Small Outer Case	1 ea
7112-9402	Lid for Outer Case	1 ea
7167-4021	TRIGEN Base Tray	1 ea

Instruments

Cat. No.	Description	Tray Qty	Cat. No.	Description	Tray Qty
7163-1066	Medium Hexdriver	1 ea	7167-4076	T-Handle	1 ea
7163-1068	Short Hexdriver	1 ea	7167-4077	Reducer	1 ea
7163-1116	12.5mm Entry Reamer	1 ea	7167-4078	Obturator	1 ea
7163-1140	Guide Bolt Wrench	1 ea	7167-4079	Ruler	1 ea
7163-1152	9.0mm Drill Sleeve	2 ea	7167-4080	Gripper	1 ea
7163-1161	Multipurpose Driver	1 ea	7167-5081	Cannulated Impactor-Medium	1 ea
7163-1186	Mini Connector	1 ea	7167-4082	Slotted Hammer	1 ea
7163-1189	Screw Depth Gauge	1 ea	7167-4083	4.0mm Drill Sleeve	3 ea
7167-4000	Cannulated Awl	1 ea	7167-4084	Screw Driver Release Handle	1 ea
7167-4060	Entry Portal Tube	1 ea	7167-4085	Screw Length Sleeve	1 ea
7167-4074	3.2mm T-Handle Trocar	1 ea	7167-4092	Entry Portal Handle	1 ea
7167-4075	Honeycomb	1 ea			

* For cleaning and sterilization instructions, please ask your local sales representative or go to the following website <http://www.smith-nephew.com/professional/resources/decontamination-and-sterilization-methods/>

* Instrument Set pictured with additional instruments

TRIGEN® META-TAN® Instrument Tray

Cat. No.	Description	Qty
7163-1504	META-TAN Instrument Tray	1
7163-1506	META-TAN Instrument Tray Lid	1
7163-1507	META-TAN Instrument Inner Tray	1

TRIGEN META-TAN Instruments

Cat. No.	Description	Qty
7163-1024	Percutaneous Guide Bolt	2
7163-1025	A-P Alignment Tower	1
7163-1039	14mm Channel Reamer	1
7163-1278	Large Nail Extractor	1
7163-1410	META-TAN Alignment Arm	1
7163-1418	META-TAN Lag Screw Drill Sleeve	1
7163-1426	META-TAN Guide Pin Sleeve	1
7163-1428	META-TAN Comp Screw Drill	1
7163-1432	META-TAN Lag Screw Drill	1
7163-1434	META-TAN Anti Rotation Bar	1
7163-1440	META-TAN Lag Screw Driver	1
7163-1444	META-TAN Comp Screw Driver	1
7163-1445	15mm Channel Reamer	1
7163-1448	META-TAN Comp Screw Starter Drill	1
7163-1450	META-TAN Lag Screw Tap	1
7163-1451	META-TAN Drill Guide	1
7163-1452	META-TAN Drop	1
7167-4558	Lag Screw Length Gauge	1

*For cleaning and sterilization instructions, please ask your local sales representative or go to the following website <http://www.smith-nephew.com/professional/resources/decontamination-and-sterilization-methods/>

Disposables

Cat. No.	Description
7163-1436	3.2mm x 343mm Guide Pin
7163-1121	4.0mm Long AO Pilot Drill, 333mm
7163-1123	4.0mm Short AO Pilot Drill, 161mm
7163-1626	3.0mm x 1000mm Ball Tip Threaded Guide Rod

Replacement Parts

Cat. No.	Description
7167-4087	Lag Wrench Retaining Rod Assembly
7167-4088	Compression Screw Hexdriver Shaft

TRIGEN® META-TAN® Nails

9mm Diameter Nails (30-46cm)

Left (Lime)	Right (Rose)	Length
7164-9530	7164-0530	30
7164-9532	7164-0532	32
7164-9534	7164-0534	34
7164-9536	7164-0536	36
7164-9538	7164-0538	38
7164-9540	7164-0540	40
7164-9542	7164-0542	42
7164-9544	7164-0544	44
7164-9546	7164-0546	46

10mm Diameter Nails (30-46cm)

Left (Lime)	Right (Rose)	Length
7164-9630	7164-0630	30
7164-9632	7164-0632	32
7164-9634	7164-0634	34
7164-9636	7164-0636	36
7164-9638	7164-0638	38
7164-9640	7164-0640	40
7164-9642	7164-0642	42
7164-9644	7164-0644	44
7164-9646	7164-0646	46

11.5mm Diameter Nails (30-46cm)

Left (Lime)	Right (Rose)	Length
7164-9730	7164-0730	30
7164-9732	7164-0732	32
7164-9734	7164-0734	34
7164-9736	7164-0736	36
7164-9738	7164-0738	38
7164-9740	7164-0740	40
7164-9742	7164-0742	42
7164-9744	7164-0744	44
7164-9746	7164-0746	46

13mm Diameter Nails (30-46cm)

Left (Lime)	Right (Rose)	Length
7164-9830	7164-0830	30
7164-9832	7164-0832	32
7164-9834	7164-0834	34
7164-9836	7164-0836	36
7164-9838	7164-0838	38
7164-9840	7164-0840	40
7164-9842	7164-0842	42
7164-9844	7164-0844	44
7164-9846	7164-0846	46

META-TAN Integrated Screw Kits

Cat. No.	Description	Qty
7164-2670	META-TAN Lag/Comp Kit 70/65	1
7164-2675	META-TAN Lag/Comp Kit 75/70	1
7164-2680	META-TAN Lag/Comp Kit 80/75	1
7164-2685	META-TAN Lag/Comp Kit 85/80	1
7164-2690	META-TAN Lag/Comp Kit 90/85	1
7164-2695	META-TAN Lag/Comp Kit 95/90	1
7164-2600	META-TAN Lag/Comp Kit 100/95	1
7164-2605	META-TAN Lag/Comp Kit 105/100	1
7164-2610	META-TAN Lag/Comp Kit 110/105	1
7164-2615	META-TAN Lag/Comp Kit 115/110	1
7164-2620	META-TAN Lag/Comp Kit 120/115	1
7164-2625	META-TAN Lag/Comp Kit 125/120	1
7164-2935	META-TAN Compression Screw 35mm	1

5.0mm Internal Hex Low Profile Screws

Cat. No.	Length
7164-5025	25mm
7164-5027	27.5mm
7164-5030	30mm
7164-5032	32.5mm
7164-5035	35mm
7164-5037	37.5mm
7164-5040	40mm
7164-5042	42.5mm
7164-5045	45mm
7164-5047	47.5mm
7164-5050	50mm
7164-5052	52.5mm
7164-5055	55mm
7164-5057	57.5mm
7164-5060	60mm
7164-5062	62.5mm
7164-5065	65mm
7164-5067	67.5mm
7164-5070	70mm
7164-5072	72.5mm
7164-5075	75mm
7164-5077	77.5mm
7164-5080	80mm
7164-5085	85mm
7164-5090	90mm
7164-5095	95mm
7164-5100	100mm
7164-5105	105mm
7164-5110	110mm

TRIGEN^o Reamer Set

Set No. 7167-1212

Cat. No.	Description	Qty
7111-8200	SculptOR Flexible Reamer	1ea
7163-1130	Flexible Reamer Extender	1ea
7111-8231*	9.0mm End Cutting Reamer Head	1ea
7111-8232	9.0mm Reamer Head	1ea
7111-8233	9.5mm Reamer Head	1ea
7111-8234	10.0mm Reamer Head	1ea
7111-8235	10.5mm Reamer Head	1ea
7111-8236	11.0mm Reamer Head	1ea
7111-8237	11.5mm Reamer Head	1ea
7111-8238	12.0mm Reamer Head	1ea
7111-8239	12.5mm Reamer Head	1ea
7111-8240	13.0mm Reamer Head	1ea
7111-8241	13.5mm Reamer Head	1ea
7111-8242	14.0mm Reamer Head	1ea
7111-8243*	14.5mm Reamer Head	1ea
7111-8244*	15.0mm Reamer Head	1ea
7111-8245*	15.5mm Reamer Head	1ea
7111-8246*	16.0mm Reamer Head	1ea

Set Screws

For use only with integrated screws

Cat. No.	Description
7164-2936	META-TAN 0mm Set Screw
7164-2937	META-TAN 5mm Set Screw
7164-2938	META-TAN 10mm Set Screw

Standard TRIGEN Nail Caps

(For use only when Set Screw not used)

Cat. No.	Length
7163-4000	0mm
7163-4005	5mm
7163-4010	10mm
7163-4015	15mm
7163-4020	20mm

Smith & Nephew, Inc.
1450 Brooks Road
Memphis, TN 38116
USA

www.smith-nephew.com

Telephone: 1-901-396-2121
Information: 1-800-821-5700
Orders/Inquiries: 1-800-238-7538